

MOTORHOME OWNER'S MANUAL



**GULF STREAMERS
INTERNATIONAL RV CLUB
APPLICATION-PAGE 32**

GULF STREAM COACH OPERATOR'S MANUAL

Congratulations!

You are the proud owner of a new GULF STREAM COACH motor home, a remarkable recreational vehicle that has been engineered, tested and built to meet your traveling and relaxation needs for many pleasurable years to come.

Many thousands of individuals have preceded you onto the highways of America, Canada and Mexico in GULF STREAM vehicles, enjoying the beauty of nature and the companionship of good people. Through personal contacts, both on the road and over the phone, GULF STREAM's engineering and manufacturing staff has learned a lot about how our customers utilize their vehicles. We've put thousands of miles on our own test vehicles over the same roads many of our customers travel each year.

It's been our experience that if a customer plans well, follows the basic rules of the road and the design limitations placed on their vehicle and its equipment, that they will enjoy thousands of carefree miles.

That's why we've included this operator's manual in your Owner's Packet along with the individual instruction booklets for all your appliances, optional equipment and detailed Operator's Manuals from the manufacturer of your chassis and motor. The more information you have available to you, the more you will get out of your new vehicle.

Please read over this manual and all the other owner's manuals included in your packet. It will make your initial trips in your new GULF STREAM much more pleasurable and save time in the long haul.

Good traveling and good camping!

Sincerely,

GULF STREAM COACH, INC.
PO Box 1005
Nappanee, Indiana 46550

TABLE OF CONTENTS

GULF STREAM WARRANTY	1
LP GAS SAFETY	2
GENERAL SAFETY	3
SEAT BELT USAGE.....	3
CHILD'S SAFETY SEATS.....	3
SEAT BELT MAINTENANCE.....	4
SEAT BELT MOUNTING.....	4
FIRE SAFETY.....	4
SMOKE DETECTOR.....	4
CARBON MONOXIDE SAFETY.....	4
LP GAS SAFETY.....	5
GASOLINE TANK SAFETY.....	5
VEHICLE LOADING	5
CARRYING CAPACITY.....	5
LOADING TIPS.....	5
MANUFACTURER'S LABELS.....	6
FEDERAL WEIGHT DEFINITIONS.....	6
DETERMINING WEIGHT AND WEIGHT DISTRIBUTION.....	7
METHOD OF WEIGHING YOUR VEHICLE.....	7
WEIGHT DISTRIBUTION FORMULAS.....	7
VEHICLE WEIGHT PLANNING GUIDE.....	8
AIR BAG WARNING.....	8
DANGERS OF OVERLOADING.....	8
VEHICLE TOWING (DINGHY).....	9
VEHICLE WEIGHT INFORMATION LABEL.....	9
TIRES	9
TIRE MARKINGS.....	9
TIRE LOAD RATINGS.....	9
TIRE AIR PRESSURE.....	9
TIRE MAINTENANCE.....	9
EMERGENCY TOWING OF THE MOTOR HOME	10
DAY-TO-DAY OPERATION	10
DRIVING TECHNIQUES.....	10
GROUND CLEARANCE.....	10
WARM WEATHER/HIGH ELEVATION OPERATION.....	10
DRIVER CONTROLS	10
BRAKES.....	10
ANTI-LOCKING BRAKING SYSTEMS (ABS).....	11
PAC BRAKES AND JAKE BRAKES.....	11
DASHBOARD INSTRUMENTS.....	11
UNUSED DASHBOARD SWITCH LOCATIONS.....	12
DASH SWITCH SYMBOLS.....	12
STARTING AND VEHICLE WARM UP.....	12
TURBO DIESEL OPERATING INSTRUCTIONS.....	12
JUMP STARTING.....	12
COACH SYSTEMS	13
SAFETY.....	13
ELECTRICAL.....	13
12-VOLT/110-VOLT.....	13
30-AMP AND 50-AMP 110-VOLT SERVICE.....	14
POWER CONVERTER.....	15
GROUND FAULT INTERRUPTER.....	15
AUTOMOTIVE 12-VOLT SYSTEM.....	15
BATTERY.....	16
BATTERY TYPES AND CHARGING.....	16
ONBOARD AUXILIARY POWER GENERATOR.....	16
INVERTER.....	16

MONITOR PANEL.....	17
SOLAR CHARGER.....	17
TELEVISION 12 VOLT ELECTRICAL CONNECTION.....	17
TV ANTENNA AND CABLE CONNECTIONS.....	17
LP GAS	18
GENERAL.....	18
CLIMATE DIFFERENCES.....	18
OPERATION.....	18
FILLING THE LP TANK.....	19
GAS LINE CHECK.....	19
REGULATOR PRESSURE.....	19
GAS TANK AND REGULATOR FREEZE UP.....	19
HOSE REPLACEMENT.....	19
REGULATOR VENT MAINTENANCE.....	19
PLUMBING	20
FRESH WATER.....	20
CITY WATER.....	20
WATER TANK.....	20
QUICK FILL WATER SUPPLY.....	20
SANITIZING THE WATER TANK.....	20
WATER PUMP.....	21
SECONDARY WATER PUMP SWITCH.....	21
WINTERIZING THE WATER PUMP.....	21
WATER MANIFOLD SYTEM.....	21
WINTERIZING BYPASS ON MANIFOLD.....	21
DRAINAGE AND SEWER.....	21
DRAINAGE P-TRAPS.....	22
HOLDING TANKS.....	22
EMPTYING HOLDING TANKS.....	22
HOLDING TANK MAINTENANCE.....	22
DO'S AND DON'TS OF HOLDING TANK USE.....	22
HOLDING TANK FLUSH SYSTEM.....	22
WATER SYSTEM WINTERIZING.....	23
APPLIANCES	23
WATER HEATER.....	24
RANGE.....	24
MICROWAVE.....	24
REFRIGERATOR.....	24
FURNACE.....	24
AIR CONDITIONER (ROOF).....	25
FANTASTIC FAN OPERATION.....	25
EFFECTS OF LONG TERM OCCUPANCY	25
SLIDE OUT SYSTEMS	25
SLIDE OUT KILL SWITCH.....	26
SLIDE OUT BREAKER SWITCH.....	26
SLIDE OUT WEATHER SEALS.....	26
VEHICLE MAINTENANCE	26
CORROSION PROTECTION.....	27
LEVELING JACKS	27
LEVELING JACK CIRCUIT BREAKER.....	27
AWNINGS	27
AWNING CARE.....	28
REPORTING SAFETY DEFECTS	28
PRE-TRIP CHECKLIST	29
INDEX	30
GULF STREAMERS INTERNATIONAL RV CLUB APPLICATION	32

GULF STREAM WARRANTY AND WARRANTY SERVICE

GULF STREAM COACH, INC. LIMITED WARRANTY IN THE UNITED STATES AND CANADA

1. WHAT IS COVERED

Your new recreational vehicle has a limited warranty by Gulf Stream Coach, Inc. ("Gulf Stream") to the original purchaser as follows:

- a) A two (2) year or 24,000 miles of use warranty (whichever comes first) against structural defects in floors, walls and roof.
- b) A full one (1) year or 12,000 mile total use warranty (whichever comes first) under normal use against defects in materials and/or workmanship in the construction of the vehicle and its original components.

The warranty coverage starts on the date the original retail purchaser takes possession of such recreational vehicle. This Limited Warranty covers only those defects which occur or exist within the period or periods referenced above and which are specifically identified to Gulf Stream Coach, Inc. in the manner specified in Section 3 of this Limited Warranty. All obligations of Gulf Stream pursuant to this Limited Warranty are limited to replacing or repairing the defective part or component.

This Limited Warranty is expressly IN LIEU of any other express warranty and is further IN LIEU of any implied warranty, including, but not limited to, any implied WARRANTY OF MERCHANTABILITY or FITNESS for a particular purpose except as may otherwise be required by applicable valid Federal or State law at time of manufacture.

2. WHAT ARE THE DEALER'S OBLIGATIONS

The independent Gulf Stream dealer, by agreement with Gulf Stream, will maintain the recreational vehicle until retail sold; will perform a comprehensive pre-delivery check procedure and inspection; will repair or replace any identified defective parts; will correct identified defects in workmanship; will present the retail owner with a copy of this warranty prior to the retail owner's entering into any written contract to purchase a recreational vehicle; and will mail to Gulf Stream a warranty registration notice and the signed Limited Warranty.

3. WHAT ARE THE RETAIL OWNER'S OBLIGATIONS

The retail owner is responsible for the normal maintenance as described in the Owner's Manual; however, minor adjustments (such as adjustments to the interior or exterior doors, LP regulator pressure, cabinet latches, TV antenna control, etc.) will be performed by the dealer during the first 90 days of warranty coverage. Thereafter, such adjustments are the responsibility of the owner as normal maintenance unless required as a direct result of repair or replacement of a defective part under this Limited Warranty.

If a problem occurs which the owner thinks is covered by this Limited Warranty, the owner is responsible to contact Gulf Stream Coach, Inc. by certified mail, return receipt requested, giving specific notice of the problem(s) being experienced with the recreational vehicle. Such notice must be sent to the Director of Service, Gulf Stream Coach, Inc., P.O. Box 1005, Nappanee, Indiana 46550. Gulf Stream will arrange for repair or replacement of parts or workmanship identified as defective by Gulf Stream. The owner is advised that he/she must notify Gulf Stream of any items believed to require warranty service. Gulf Stream reserves the right to cure all warranty claims. Service work conducted by any party not specifically authorized by Gulf Stream to undertake such work is specifically not covered by this Limited Warranty and WILL VOID THIS LIMITED WARRANTY.

The owner agrees to maintain all evidence of any defect or damage through the ultimate resolution of any claim and make such evidence available to Manufacturer and further agrees that the failure to preserve evidence will result in loss of the claim.

The owner, at his expense, will deliver the recreational vehicle to the dealer or authorized repair location or manufacturing plant for warranty service as designated.

4. WHAT IS NOT COVERED BY EXPRESS WARRANTY

- THIS LIMITED WARRANTY DOES NOT COVER RETAIL SOLD UNITS FOR WHICH GULF STREAM HAS NOT RECEIVED THE GULF STREAM COACH, INC. WARRANTY REGISTRATION NOTICE.
- THE AUTOMOTIVE SYSTEM (INCLUDING THE CHASSIS AND DRIVE TRAIN AND ANY PART OF THAT CHASSIS ASSEMBLED BY THE CHASSIS MANUFACTURER), TIRES, BATTERIES, AUXILIARY GENERATOR POWER PLANTS WHICH ARE COVERED BY THE RESPECTIVE MANUFACTURERS OF THESE COMPONENTS.
- FAILURE WHICH MAY BE CAUSED BY, OR RELATED TO ABUSE, MISUSE, NEGLIGENCE, OR ACCIDENT, FAILURE WHICH MAY BE RELATED TO ALTERATION OR MODIFICATION, FAILURE AS A RESULT OF NOT FOLLOWING INSTRUCTIONS CONTAINED IN THE OWNER'S MANUAL.
- NORMAL DETERIORATION DUE TO WEAR OR EXPOSURE, SUCH AS FADING OF FABRICS OR DRAPES, CARPET WEAR, EXTERIOR SURFACES, ETC.
- MAINTENANCE ITEMS: SUCH AS LIGHT BULBS, FUSES, WIPER BLADES, LUBRICANTS, MINOR ADJUSTMENTS.
- USE OF THE RECREATIONAL VEHICLE FOR ANY COMMERCIAL OR RENTAL PURPOSE VOIDS THE WARRANTY FROM THE TIME THAT THE VEHICLE IS FIRST USED FOR A COMMERCIAL OR RENTAL PURPOSE AND AT ALL TIMES THEREAFTER.
- MOTOR HOMES ON WHICH THE ODOMETER READING HAS BEEN ALTERED.
- TRANSPORTATION TO AND FROM DEALER OR MANUFACTURING PLANT LOCATION, AND CONSEQUENTIAL AND INCIDENTAL EXPENSE SUCH AS, BUT NOT LIMITED TO, LOSS OF TIME, COMMERCIAL LOSS, LOSS OF USE, TOWING CHARGES, LODGING, FOOD, PHONE CALLS, INCONVENIENCE, BUS OR PLANE FARES, OR RENTAL CHARGES.
- ANY DEFECTS OR SHORTAGES READILY APPARENT ON DELIVERY TO THE INITIAL RETAIL PURCHASER UNLESS NOTED ON DELIVERY SHEET COMPLETED BY THE DRIVER TRANSPORTING THE RECREATIONAL VEHICLE TO THE INDEPENDENT DEALER.
- ANY COMPONENT PART WHICH POSSESSES ITS OWN WARRANTY FROM A PARTY OTHER THAN GULF STREAM.

5. IMPORTANT FACTS

- Please inspect your recreational vehicle at the time of delivery and make sure you accept it as delivered to you. This recreational vehicle has been sold to an independent dealer, and not an agent of Gulf Stream, for resale in the ordinary course of the dealer's business, on terms and conditions and equipped as he and you determine, and your agreement is solely with the dealer, not Gulf Stream. Gulf Stream does not participate in retail sales or retail contracts in any instance, other than by terms of this Limited Warranty.
- Gulf Stream reserves the unrestricted right at any time and from time to time to make changes in the design of and/or improvements upon its product without thereby imposing any obligation upon itself to make corresponding changes or improvements in or upon its products already manufactured. Gulf Stream further reserves the right to substitute parts or components of substantially equal quality in any warranty service required by operation of this Limited Warranty.
- Like any other product, a recreational vehicle and the products installed in it will require care and maintenance attention by the owner and occupants. Please read and follow all care and maintenance manuals and instructions supplied with your recreational vehicle.

6. JURISDICTION AND APPLICABLE LAW

Exclusive jurisdiction for deciding any claims, demands or causes of action for defects or representations of any nature or damages due from such defects or representations shall be in the courts in the State of Manufacture. The laws applicable to any litigation, dispute, mediation, arbitration or any claim whatsoever arising, from the sale, purchase, or use of the recreational vehicle shall be those of the State of Manufacture.

7. ARBITRATION - MEDIATION

At the option of Gulf Stream, any dispute concerning a manufacturing defect shall be subject to mediation or arbitration conducted in the State of

Manufacture. In the case of arbitration, the arbitrator shall be selected from the American Arbitration Association (AAA).

Gulf Stream Coach, Inc. is not responsible for any representation or warranty that is not herein stated. Some states do not allow the exclusion or limitation of incidental or consequential damages.

This warranty gives you specific legal rights and you may also have other rights that may vary from state to state.

I HEREBY ACKNOWLEDGE THAT I HAVE READ AND RECEIVED A COPY OF THE ABOVE WARRANTY FOR GULF STREAM COACH PRIOR TO ENTERING INTO ANY CONTRACT TO PURCHASE MY GULF STREAM RECREATIONAL VEHICLE AND AGREE TO ABIDE BY ALL OF ITS TERMS AND PROVISIONS INCLUDING, BUT NOT LIMITED TO, THE PROVISIONS HEREOF PROVIDING THAT THE EXCLUSIVE JURISDICTION FOR ANY CLAIMS WHATSOEVER SHALL BE IN THE COURTS IN THE STATE OF MANUFACTURE AND THAT THE APPLICABLE LAW SHALL BE THE LAW OF THE STATE OF MANUFACTURE

MODEL _____ SERIAL NUMBER _____

DATE _____ SIGN _____

SIGN _____

Effective December 1997

Authorized dealers are independent contractors and independently owned businesses. This is also true of the authorized chassis service dealers.

Gulf Stream Coach, Inc. desires that you have full enjoyment of your new Gulf Stream recreational vehicle. If for any reason your vehicle is out of service and cannot be used because of a manufacturing or chassis defect for a cumulative total of seven (7) days during the warranty period, you are to immediately contact Gulf Stream Coach, Inc., by certified mail, return receipt requested, setting forth the service problems and asking for immediate assistance. Gulf Stream Coach, Inc. is ready, willing and able to make every effort for a quick response.

WARRANTY SERVICE

1. Warranty service, under your Limited Warranty, is to be performed by your authorized Gulf Stream dealer from whom you purchased your unit or by an authorized service center for those appliances and equipment not maintained by Gulf Stream. Your dealer has a vested interest in your satisfaction, therefore, if at all possible; it is best to return to your dealer for service.
2. If you are traveling or move, any authorized dealer may provide service. Keep your warranty registration form with the vehicle at all times since it must be presented for warranty service. This form is your proof of purchase and provides the date of retail sale, both of

which are necessary to determine warranty eligibility.

3. If you cannot locate an authorized Gulf Stream dealer contact:
GULF STREAM COACH, INC.
PO Box 1005
Nappanee, IN 46550
1.800.482.6456
4. Other warranties - The retail customer is responsible for completing and forwarding warranty forms for all items not covered by either the chassis manufacturer's or Gulf Stream's warranty.
5. YOUR WARRANTY IS NOT VALID UNTIL IS HAS BEEN SIGNED AND SUBMITTED TO GULF STREAM COACH, INC!

Your authorized Gulf Stream Dealer from whom you purchased your unit will assist you in service, maintenance, selection of options, and instructions concerning the operation of your recreational vehicle. Occasionally, a warranty or service matter may not be handled to your satisfaction. In this case, we recommend that you discuss the problem with dealer management. If you are unable to find satisfaction at the dealer level, please contact the Gulf Stream Service Department, where we will make our best effort to reach an agreeable solution. In most instances, we will eventually refer you back to the local dealer with our recommendations.

LP GAS HEATING SYSTEM AND LP GAS APPLIANCE SAFETY REGULATIONS

The United States Government requires that the manufacturer of this recreational vehicle provide the following safety information that has been provided by the National Fire Prevention Association (NFPA) and the American National Standards Institute (ANSI). The information contained below will also be found, along with additional information, in other appropriate sections of this operator's manual. Refer to the Table of Contents and the Index.

WARNING: LP GAS CONTAINERS SHALL NOT BE PLACED OR STORED INSIDE THE VEHICLE. LP GAS CONTAINERS ARE EQUIPPED WITH SAFETY DEVICES THAT RELIEVE EXCESSIVE PRESSURE BY DISCHARGING GAS TO THE ATMOSPHERE.

WARNING: IT IS EXTREMELY DANGEROUS TO USE COOKING APPLIANCES FOR COMFORT HEATING. COOKING APPLIANCES NEED FRESH AIR FOR SAFE OPERATION. BEFORE OPERATION

(1) OPEN THE OVERHEAD VENT OR TURN ON AN EXHAUST FAN AND (2) OPEN A NEARBY WINDOW. A WARNING LABEL HAS BEEN PLACED IN THE COOKING AREA OF THE VEHICLE TO REMIND YOU THAT YOU MUST PROVIDE AN ADEQUATE SUPPLY OF FRESH AIR FOR CUMBUSTION. UNLIKE HOMES, THE AMOUNT OF AIR IN AN RV IS LESS DUE TO ITS LIMITED SIZE (VOLUME). PROPER VENTILATION WHEN USING COOKING APPLIANCES WILL AVOID THE DANGERS OF ASPHYXIATION. THE THREAT OF ASPHYXIATION INCREASES WHEN A COOKING APPLIANCE IS USED FOR LONG PERIODS OF TIME, THUS, THEY SHOULD NEVER BE USED TO HEAT THE INTERIOR OF THE VEHICLE.

WARNING: PORTABLE FUEL-BURNING EQUIPMENT, INCLUDING CHARCOAL GRILLS AND STOVES, SHALL NOT BE USED INSIDE THE RV. THE USE OF THIS CATEGORY OF EQUIPMENT INSIDE AN ENCLOSED SPACE MAY CAUSE ASPHYXIATION AND CREATES A FIRE HAZARD.

WARNING: DO NOT BRING OR STORE LP GAS CONTAINERS, GASOLINE OR OTHER FLAMMABLE LIQUIDS INSIDE THE VEHICLE DUE TO THE POSSIBILITY OF EXPLOSION AND FIRE.

A warning label has been attached near the LP gas container. The label reads: DO NOT FILL CONTAINER (S) TO MORE THAN 80 PERCENT OF CAPACITY.

Uncontrolled gas flow can result from overfilling of LP gas containers, resulting in a fire or explosion. A properly filled container will contain approximately 80 percent of its volume as liquid.

The following label has been placed in the cooking area of the vehicle:

IF YOU SMELL GAS:

1. Extinguish any open flame, pilot light and smoking material.
2. Do not touch any electrical switch.
3. Shut off the LP gas supply at the tank valve(s) or gas supply connection.
4. Open doors and other ventilating openings.
5. Leave the area until the odor clears.
6. Have the gas system checked and leakage source corrected before using again.

LP gas regulators must always be installed with the diaphragm vent facing down. Regulators that are not in compartments have been equipped with a protective cover. Make sure the regulator vent faces down and the cover is kept in place to minimize vent blockage; blockage could result in excessive gas pressure and, therefore, possibly cause a fire or explosion.

Notice: All LP gas regulators are factory tested for proper pressure output. Pressure output should be checked periodically by a qualified LP dealer. Only qualified persons should install, adjust or service LP gas regulators. If service is needed contact a qualified LP dealer.

APPROACHING THE OPEN ROAD IN A PROFESSIONAL MANNER

As a proud owner and operator of a GULF STREAM motor home you will be commanding one of the larger privately owned vehicle using the nation's roadways.

The only vehicles that will be as large or larger than your "rig" will be trucks and buses of the professional driver. Don't let the car-like handling characteristics of your new GULF STREAM lull you into a less than vigilant attitude towards highway driving. Your safety, the safety of your passengers and those on the road alongside you depend on your "professional" driving attitude.

Professional drivers approach their driving responsibilities methodically from the outset of the trip. They include thorough pre-trip planning and equipment checks. They also include equipment checks along the route and take into consideration driver fatigue.

GULF STREAM COACH, INC. provides this operator's manual so that you can approach your driving in the most professional manner possible. Read the manual carefully. Learn your vehicle's personality. And keep this manual handy for ready reference. Before you know it, you and your machine will be a "team" and you'll be proud of the professional manner in which you approach the serious business of driving a large vehicle on the open road.

PREPARING FOR THE ROAD

GENERAL SAFETY

Seat Belt Usage

All seats designated for occupancy during travel are equipped with seatbelts for the protection and safety of passengers. Rear facing seats, as used in the dining area, as well as those seats labeled "Not for occupancy while vehicle is in motion", are not equipped with seatbelts and should not be occupied while the vehicle is in motion.

NOTE: MANY STATES HAVE PASSED LAWS THAT REQUIRE SEATBELTS TO BE WORN BY ALL PASSENGERS WHEN THE VEHICLE IS IN MOTION.

Child's Safety Seats

NOTE: MANY STATES HAVE PASSED LAWS THAT REQUIRE ALL PASSENGERS UNDER TWO YEARS BE RESTRAINED BY USE OF AN INFANT'S SAFETY SEAT, AND THOSE UNDER FOUR YEARS BE RESTRAINED BY A CHILD SAFETY SEAT. THESE SEATS MUST BE PROPERLY FITTED TO A STANDARD LAP OR SHOULDER BELT. CONSULT SEAT MANUFACTURER'S INSTRUCTIONS FOR PROPER SECURING OF THESE SAFETY SEATS.

MANY STATES HAVE SPECIFICALLY OUTLAWED THE PRACTICE OF HOLDING INFANTS IN THE LAPS OF VEHICLE DRIVERS AND PASSENGERS.

AN INFANT OR CHILD SEAT SHOULD NEVER BE PLACED IN THE FRONT PASSENGERS SEAT. VEHICLES EQUIPPED WITH AIRBAGS CAN INJURE OR KILL CHILDREN IN THIS LOCATION IF AN ACCIDENT OCCURS.

When using seatbelts, always take up any slack belt by pulling the excess strap through the adjusting system. Unlatch the belt by pushing the button on the buckle.

Seat Belt Maintenance

SEAT BELT ASSEMBLIES SHOULD BE PERIODICALLY INSPECTED TO ASSURE THAT THEY HAVE NOT BECOME DAMAGED AND THAT THEY REMAIN IN PROPER OPERATING CONDITION, PARTICULARLY IF THEY HAVE BEEN SUBJECTED TO SEVERE STRESS.

Seat belt mounting

All seat belts are mounted per FMVSS Federal requirements and should never be relocated. Anyone who relocates a seat belt accepts full responsibility of it's consequences.

FIRE SAFETY

Prevention is the best form of fire safety. Carefully follow the instructions for the care and operation of the various appliances in your vehicle (see appropriate sections).

Follow the same basic rules of fire prevention that you use at home. DO NOT SMOKE IN BED. DO NOT OVERLOAD THE ELECTRICAL SYSTEM. DO NOT PERMIT CHILDREN NEAR THE LP GAS CONTROLS OR CONTAINER. DO NOT STORE FLAMMABLE LIQUIDS INSIDE THE UNIT.

Carry-over your fire preparedness from home to your RV by having a pre -planned escape route. BE SURE

EVERYONE KNOWS WHERE THE EMERGENCY EXITS ARE LOCATED AND HOW THEY OPERATE.

Your RV has been equipped with a fire extinguisher. MAKE SURE EVERYONE KNOWS WHERE IT IS LOCATED, HOW TO OPERATE IT AND WHAT TYPES OF FIRES IT IS DESIGNED TO HANDLE.

Check the extinguisher on a regular basis to make sure it is charged.

SMOKE DETECTOR

All units are equipped with a smoke detector. Check its operation on a regular basis. If it does not check properly, get is serviced or replaced prior to using the coach again.

NOTE: IF A FIRE DOES START WITHIN THE UNIT, GET ALL OCCUPANTS OUT IMMEDIATELY. IF IT IS A SMALL FIRE, USE THE FIRE EXTINGUISHER. IF THE FIRE IS NOT QUICKLY PUT OUT, GET OUT OF THE VEHICLE. CONTACT THE FIRE DEPARTMENT. IF POSSIBLE, CLOSE THE LP GAS SERVICE VALVE. MOVE A SAFE DISTANCE FROM THE VEHICLE.

CARBON MONOXIDE SAFETY

Carbon Monoxide is a colorless, odorless, tasteless gas, which can be fatal if a high concentration builds up in a sealed area over a period of time. Carbon Monoxide is a by-product of burning fuel, and is found in high concentrations in exhaust from gas burning engines. A water heater or furnace operating improperly can also produce Carbon Monoxide. Under normal conditions your coach should be free from Carbon Monoxide at any given time. Due to the safety hazards of Carbon Monoxide (CO), each Gulf Stream motor home is equipped with a CO Detector.

Carefully read the instructions included with your CO detector to ensure proper use and maintenance. Most CO detectors require only occasional dusting and weekly testing. DO NOT use any type of cleaner when dusting your CO detector. Doing so may render the unit useless without warning.

Carbon Monoxide is often confused with illness such as "flu like symptoms". (Headaches, Nausea, Dizziness). Such symptoms should be discussed with all vehicle occupants. RV certified CO detectors will sound an alarm if 100 PPM (parts per million) of CO is present within 90 minutes. 50 PPM is allowed in a work place for up to 8 hours. Cigarette smoke contains about 5 PPM Carbon Monoxide.

If your CO alarm sounds, exit the vehicle immediately. After exiting the vehicle take a head

count and make sure everyone is accounted for. Air out the vehicle and check again to ensure that the alarm came from the CO detector, as your vehicle is also equipped with a smoke detector and LP gas detector (optional). Following instructions included with your CO detector is recommended.

LP GAS SAFETY

WARNING:

SHUT OFF ALL LP GAS SYSTEMS BEFORE FILLING THE GASOLINE TANK.

LP appliances should never be operated while the vehicle is in motion.

If the pungent odor of LP gas is detected immediately shut off the LP gas valve and check the LP gas label for further instructions. Your unit may be equipped with an LP gas leak detector that will help you detect the presence of LP gas. However, this detector should not be relied upon solely; if you detect the smell of LP gas, shut off the gas valve immediately.

Check other sections of this manual for more information on the LP gas system.

GASOLINE TANK SAFETY

WARNING:

MODERN FUEL SYSTEMS MAY BUILD UP VAPOR PRESSURE WITHIN THE GASOLINE TANK AS THE GASOLINE WARMS DURING VEHICLE USE AND DURING HOT WEATHER. UNDER CERTAIN CONDITIONS THE SUDDEN RELEASE OF THIS BUILT-UP PRESSURE BY THE REMOVAL OF THE GASOLINE CAP CAN SPRAY GASOLINE FROM THE FILLER OPENING, CREATING A POTENTIAL HAZARD.

WHEN REMOVING THE GASOLINE FILLER CAP, ROTATE IT SLOWLY TO ALLOW ANY INTERNAL PRESSURE TO BE SLOWLY RELEASED. AFTER THE "WHOOSH" OF THE RELEASED PRESSURE PASSES, COMPLETELY REMOVE THE CAP.

ALWAYS REPLACE A LOST GAS CAP WITH A CAP OF THE SAME DESIGN TO FORESTALL ANY ADDED PROBLEMS.

VEHICLE LOADING

Carrying Capacity

During the design and development of our motor homes, the number and size of storage compartments and the liquid tank capacities are maximized for value and convenience. If the motor home operator fills all

liquid tanks to capacity, fills all storage compartments and cupboards to maximum volume and fills all available seat belt positions with passengers, the motor home will probably be overloaded. According to National Highway Traffic Safety Administration figures, an average vehicle occupant weighs 150 pounds, each gallon of gasoline weighs six (6) pounds and each gallon of water weighs over eight (8) pounds. The operator is responsible for analyzing the conditions in which the motor home will be utilized for each trip, and ensuring the vehicle is not overloaded.

The number of passengers and placement of cargo will affect the amount of water and cargo that you can carry. The passenger capacity will vary depending on whether the vehicle is being used for overnight camping or day use. A smaller passenger capacity for camping will provide a reasonable cargo capacity for trips taking more than one day. The passenger capacity for day use can be larger providing that less cargo is carried for trips and activities not involving overnight stays. It may be necessary to reduce the amount of water carried and unload some cargo items normally carried for camping in order to provide carrying capacity for the additional one (1) day use passengers.

Thoughtful consideration of the weight placed in the motor home can yield important benefits:

- Maximum flexibility in the use of the liberal storage facilities provided in the motor home;
- Improved handling characteristics and ride comfort;
- Better fuel mileage and reduced tire wear.

Periodically reweigh your motor home. Different traveling configurations may change your loading and weight pattern.

WARNING: DO NOT EXCEED THE RATED LOAD OF THE MOTOR HOME OR THE RATED LOAD OF ANY AXLE!

NOTE: THE CARRYING CAPACITY OF YOUR MOTOR HOME CAN BE DETERMINED BY WEIGHING, AS SHOWN IN FIG. 2. THE SHIPPING WEIGHT DOES NOT NORMALLY INCLUDE OPTIONS SUCH AS LEVELING JACKS, AWNINGS, ROOF PODS, ETC. THE WEIGHT OF THESE ITEMS MUST BE SUBTRACTED FROM THE TOTAL OF THE PASSENGER AND CARGO CARRYING CAPACITIES. IF YOU TOW A TRAILER, THE TONGUE WEIGHT OF THE TRAILER MUST BE SUBTRACTED FROM THE TOTAL OF THE PASSENGER AND CARGO CARRYING CAPACITIES.

Notice: Empty all holding tanks before filling fresh water tank otherwise you will limit cargo and/or passenger capacity. Normally campgrounds supply free dump stations which can be utilized.

Loading Tips

After you have determined how much weight you can safely carry and selected those items to make up that weight, make a list and keep it for future reference. Load the motor home and distribute the load so that you get proper weight on the axles. Do not load upper cabinets with heavy items. Secure and brace items so they won't move during travel, thereby shifting the load in the motor home. Do not load heavy items near either end of the motor home or on the rear bumper. Adjust cargo storage to keep the side to side wheel loads as equal as possible. Carry only as much water as needed for travel use or to balance the load. Always empty your waste water and sewage holding tanks before traveling.

WARNING: DO NOT INSTALL ANY TYPE OF WEIGHT CARRYING RACK OR FRAME TO THE REAR BUMPER OR ANY CHASSIS OR BODY COMPONENT OF THE MOTOR HOME. DAMAGE TO THE MOTOR HOME AND UNSTABLE HANDLING CHARACTERISTICS MAY RESULT.

WARNING: EXCEEDING THE GAWR, GVWR, OR GCWR OF YOUR MOTOR HOME CAN CAUSE UNDESIRABLE HANDLING CHARACTERISTICS AND MAY CREATE A SAFETY HAZARD. MODIFICATION OF YOUR VEHICLE BY ADDITION OF RACKS NOT SPECIFIED BY THE MANUFACTURER TO CARRY ADDITIONAL EQUIPMENT OR VEHICLE IS NOT RECOMMENDED, MAY CREATE A SAFETY HAZARD, AND MAY VOID YOUR WARRANTY.

Make a loading diagram of your properly loaded motor home. It will help you locate where specific items are stored, and will help speed the loading process. Store emergency items in a readily accessible location. Include tools, first-aid kit, rain gear, flashlight, highway warning devices, and an electric cord or light.

The difference between the empty weight and the weight of the motor home in traveling configuration is your usable load. If the loaded weight of your motor home exceeds the GVWR or the weight on any axle exceeds that axle's GAWR, the motor home is overloaded and you'll have to remove items to bring the weight down to or below the GVWR and GAWR.

All items must be considered for their weight and stored according to how heavy they are. Heavy items should be placed close to the floor and in the center of the vehicle. **DON'T FORGET TO INCLUDE THE ITEMS YOU PURCHASE ON YOUR TRIP.**

Luggage and similar cargo carried inside the vehicle must be secured to prevent possible damage in the case of a sudden stop or an accident. It is no good to survive the initial impact of an accident to be hit on the head by a flying object from inside your vehicle.

Manufacturer's Labels

Your vehicle is equipped with several federally required labels pertaining to the vehicle's weight, load capacity and operating limitations.

On the wall above or next to the driver is the federal sticker that lists the unit's manufacturer's serial number, the front and rear GROSS AXLE WEIGHT RATING (GAWR), the vehicle's GROSS VEHICLE WEIGHT RATING (GVWR), tire and wheel rim sizes, tire operating pressure, chassis serial number and the VEHICLE IDENTIFICATION NUMBER (VIN). (FIG. 1)

MFD BY  GULF STREAM COACH, INC.			
DATE OF MFGR.	INC. VEH. MFD. BY	DATE OF MFGR.	GVWR
GAWR FRONT LBS.	WITH MINIMUM TIRES	RIMS	AT PSI COLD
GAWR INTERM. LBS.	WITH MINIMUM TIRES	RIMS	AT PSI COLD
GAWR REAR LBS.	WITH MINIMUM TIRES	RIMS	AT PSI COLD
SINGLE	DUAL	THIS VEHICLE CONFORMS TO ALL APPLICABLE FEDERAL MOTOR VEHICLE SAFETY STANDARDS IN EFFECT IN	
VEHICLE ID NO.		VEHICLE TYPE	GULFSTREAM SERIAL NO.

(FIG. 1) FEDERAL STICKER

MOTORHOME WEIGHT INFORMATION					
CONSULT OWNER MANUAL(S) FOR SPECIFIC WEIGHING INSTRUCTIONS AND TOWING GUIDELINES.					
MODEL:	8404 WFD	kilograms	pounds	kilograms	pounds
SERIAL #	3652	GVWR	16327	36000	GVWR
					14059
					12067
					25608
					NCC
					1992
					4392
CARGO CARRYING CAPACITY (CCC) INFORMATION					
Your carrying capacity is affected by everything put into your motorhome. Use this chart to support your travel needs.					
		Added weight		Adjusted CCC*	
		gallons	kilograms	pounds	kilograms
					pounds
Fresh water @ 8.3 lb/gal	Fresh water	100	378	830	1615
					3562
LP-Gas @ 4.5 lb/gal	LP tank	33	68	150	1547
					3412
People @ 154 lb/each	1 Occupant		70	154	1477
					3258
	2 Occupants		140	308	1407
					3104
	3 Occupants		210	462	1337
					2950
	4 Occupants		280	616	1267
					2796
	SCWR =				CCC*
* Weights are estimated. Dealer installed equipment and towed vehicle tongue weight will reduce CCC.					
GVWR (Gross Vehicle Weight Rating) is the maximum permissible weight of this fully loaded motorhome.					
UVW (Unloaded Vehicle Weight) is the weight of this motorhome as manufactured at the factory with full fuel, engine oil and coolants.					
NCC (Net Carrying Capacity) is equal to the GVWR minus the UVW.					
CCC (Cargo Carrying Capacity) is equal to the GVWR minus each of the following: UVW, full fresh (potable) water (including water heater), full LP-Gas weight, and SCWR.					
SCWR (Sleeping Capacity Weight Rating) is the manufacturer's designated number of sleeping positions multiplied by 154 pounds (70 kilograms).					
GCWR (Gross Combination Weight Rating) is the value specified by the motorhome manufacturer as the maximum allowable loaded weight of this motorhome with its towed trailer or towed vehicle.					

(FIG. 2) WEIGHT INFORMATION LABEL

Federal Weight Definitions

GAWR: The allowable weight, INCLUDING CARGO AND PASSENGERS, which can be SAFELY supported by a specified axle.

GVWR: The maximum permissible weight of your vehicle, INCLUDING CARGO, ALL OPTIONS, PASSENGERS, GASOLINE AND WATER.

GCWR: The maximum permissible weight of your fully loaded vehicle including the weight of any towed vehicle or trailer.

Determining Weight and Weight Distribution

The total amount of weight carried by your vehicle is extremely important. It is critical that you weigh your vehicle prior to taking a trip in order to determine if you are within the weight limitations of the vehicle's suspension. CHECK THE WEIGHT. CHECK THE TIRE PRESSURE IN RELATIONSHIP TO THE WEIGHT. See the Federal Sticker for the needed information (FIG. 1).

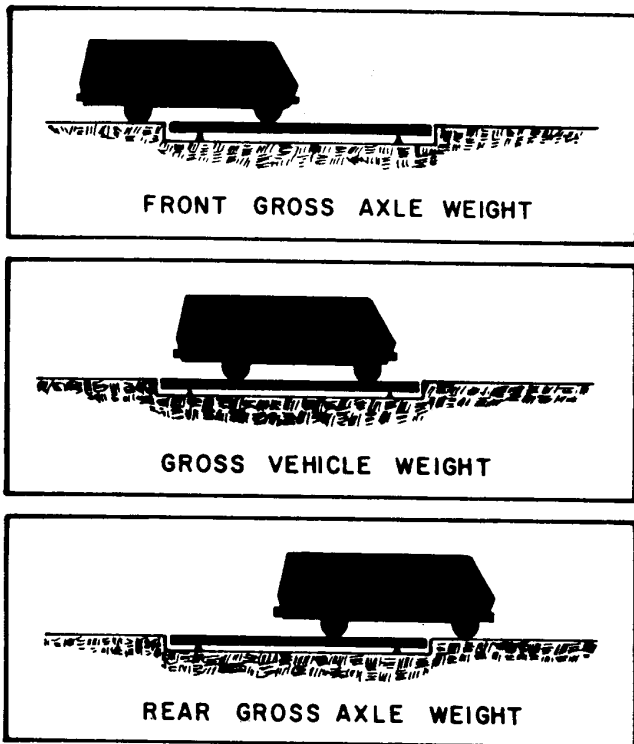

FIG. 3) WEIGHING VEHICLE ON SCALES

The Method of Weighing Your Vehicle

There are many locations where you can weigh your vehicle including grain elevators, scrap iron businesses, sand and gravel dealers and state and federal weight stations (usually listed in phone directory).

NOTE: BE SURE TO WEIGH THE VEHICLE WITH EVERYTHING IN IT INCLUDING PASSENGERS, CARGO, FULL LP, GASOLINE AND WATER.

The procedure is as follows (FIG. 3)(unless modified by the weighmaster):

1. Drive only the front axle of the unit onto the scale. Have the weight master note this weight.
2. Drive forward and place both front and rear axles onto the scale. Have the weigh master note this weight.
3. Drive forward until only the rear axle is on the scale. Have the weight master note this weight.

NOTE: COMPARE ALL WEIGHTS WITH THOSE LISTED ON THE FEDERAL ID STICKER.

If any weight exceeds the listed rating, relocate the passengers and redistribute or remove a portion of the cargo until the weight is within the proper limit as listed on the Federal ID Sticker and for which the vehicle has been engineered.

NOTE: DO NOT FORGET THAT WATER USED FROM THE FRESH WATER SUPPLY GOES INTO THE WASTE WATER HOLDING TANK. IF YOU REFILL THE FRESH WATER TANK PRIOR TO DUMPING THE WASTE WATER, THE WEIGHT OF THE VEHICLE IS SUBSTANTIALLY MORE THAN WHEN YOU WEIGHED IT AT THE START OF YOUR TRIP.

USEFUL WEIGHTS

Water.....	8.328 pounds per gallon
Gasoline.....	6.0 pounds per gallon
Propane.....	4.23 pounds per gallon

WEIGHT DISTRIBUTION FORMULAS

Inside Wheelbase: Number of inches behind front wheel divided by vehicle wheelbase.

Example for a 178 inch wheelbase: A tool chest is stored 36 inches behind the front wheel. Divided by the 178 inch wheelbase equals 20 percent of the tool chest's weight added to the rear axle and 80 percent to the front axle.

Outside Wheelbase: Determine the distance the object is from the nearest axle. Divide by the wheelbase.

Example: A motorcycle is hung on the rear bumper of an RV. It is 144 inches behind the rear axle. Divide the 144 by the vehicle's 178 inch wheelbase and you find that the motorcycle equals 80 percent more than its actual weight....in other words it acts on the vehicle as though it weighs 180 percent on the rear axle. THE EXCESS OF 100 PERCENT IS TAKEN OFF THE FRONT AXLE.

If the motorcycle weighs 300 pounds it acts on the RV as though it weighs 540 pounds! Two hundred forty pounds is also taken off the front axle.

Thus, you can see why the addition of any rack to the vehicle will have an adverse affect on the driving characteristics.

Vehicle Weight Planning Guide

The following guide will help you determine how much you can load in your vehicle. We have included the weights of common items added after the vehicle leaves the factory.

MODEL NUMBER: _____

UNIT NUMBER: _____

CHASSIS MANUFACTURER: _____

UNIT FACTORY BASE WEIGHT: _____

OPTIONS:	(Approx)LBS.
6.6 Generator	312
4.0 Generator	275
15.0 Roof AC	112
13.5 Roof AC	103
11.5 Roof AC	98
Electric Step	29
Spot Light	6
Fog Lights	3
Dash Fans	2
13" TV	23
19" TV	29
VCR	12
Awning	100
Microwave	58
Air Horns	24
Mini Satellite Dish	31
Back up Monitor	20
Hydraulic Jacks	250

OPTIONAL TOTAL: _____

FUEL WEIGHT

¼ Capacity _____

½ Capacity _____

¾ Capacity _____

Full _____

FRESH WATER WEIGHT

¼ Capacity _____

½ Capacity _____

¾ Capacity _____

Full _____

OCCUPANTS(limited to amount of seat belts)
(150 LBS. EACH) _____

GVWR = _____

SUBTRACT COMBINED

TOTAL WEIGHTS _____

FROM ABOVE - _____

EQUALS VEHICLE NET
CARRYING CAPACITY = _____

AIR BAG WARNING:

GULF STREAM COACH, INC. DOES NOT APPROVE THE USE OF AFTER MARKET SUSPENSION AIR BAGS ON ITS VEHICLES. AFTER MARKET AIR BAGS, WE HAVE DETERMINED, DO NOT PROPERLY SUPPLEMENT THE SUSPENSION. INSTEAD, THEY INTERFERE WITH THE RIDE AND HANDLING OF MOTOR HOMES ENGINEERED BY THE CHASSIS MANUFACTURER. SOME CHASSIS MANUFACTURERS HAVE SPECIFIC NOTATIONS IN THEIR CHASSIS MANUALS THE ADVISE THAT SUPPLEMENTAL AIR BAGS CAN BE DESTRUCTIVE TO THE VEHICLE AND INTERFERE WITH ITS ROAD HANDLING CAPABILITIES.

DO NOT USE SUPPLEMENTAL AIR BAGS ON YOUR MOTOR HOME! IF SUPPLEMENTAL CAPABILITY FOR THE SUSPENSION IS DESIRED, YOU ARE ATTEMPTING TO CARRY MORE CARGO THAN THE VEHICLE WAS DESIGNED FOR. UPGRADING WITH ADDITIONAL SPRINGS, HIGHER CAPACITY SHOCK ABSORBERS, CO COIL-OVER SHOCKS WILL ALSO VOID YOUR WARRANTY. ALWAYS BE MINDFUL THAT YOUR VEHICLE WAS DESIGNED FOR THE MAXIMUM WEIGHT TO CARRY MORE WEIGHT IS DANGEROUS AND SHOULD BE AVOIDED.

WE CANNOT APPROVE ANY AIR BAG INSTALLATION. BEFORE MODIFYING YOUR SUSPENSION, TALK TO YOUR CHASSIS DEALER. AVOID CAUSING POSSIBLE DAMAGE TO YOUR MOTOR HOME.

Dangers of Overloading

One of the attractive selling points of the GULF STREAM is the abundance of storage, both inside and outside the vehicle. However, there are limits to what the vehicle can carry as shown above.

When preparing for a trip and while on your travels, always be mindful of WHAT YOU ARE STORING, HOW MUCH IT WEIGHS AND WHERE YOU ARE STORING IT. BEWARE OF OVERLOADING.

In addition to causing premature wear, overloading can cause problems in the area of handling characteristics. An overloaded vehicle will take longer (time and distance) to stop in an emergency. Overloading can also cause added wear to components such as tires, wheel bearings, transmission and engine. Overloading can also cause overheating it in some instances.

The solution? Stay on top of your vehicle weight situation at all times. Know where you stand when it comes to the GVWR, GAWR and GCWR.

Vehicle Towing

Prior to towing any vehicle behind your motor home, be sure to consult your chassis manufacturer owner's manual. Determine what type of special equipment is needed to be able to tow with your motor home.

Be sure that your vehicle's GROSS COMBINED WEIGHT RATING (GCWR) has a rating capable of towing your vehicle while your motor home is loaded.

NOTE: IMPROPER USE OF YOUR UNIT AS A TOW VEHICLE MAY VOID YOUR CHASSIS WARRANTY AND MAY RESULT IN DAMAGE TO THE MECHANICAL PORTIONS OF THE CHASSIS.

NOTE: CHECK THE TOW RATING OF THE HITCH INSTALLED ON YOUR MOTOR HOME. BE SURE THAT THE COMBINED WEIGHT OF YOUR TOW VEHICLE AND TOW DOLLY (if applicable) DOES NOT EXCEED THE HITCH RATING.

Vehicle Weight Information Label

All GULF STREAM vehicles have a weight information label posted inside the kitchen cupboard. Please refer to this label to see the shipping weight of your vehicle and the net carrying capacity of your water tank. This label also contains the GULF STREAM designated GCWR. Please note that the GULF STREAM GCWR may differ from the chassis designated GCWR, and that the lower of the two must be followed.

The vehicle weight information label also contains the net carrying capacity. This is the maximum weight designated by GULF STREAM that can be utilized for cargo and passengers. Any addition of accessories by you or the dealer reduces this amount proportionally with the weight of added accessories.

Tires

The tires installed on your vehicle have been pre-selected as the proper size and weight for the type of coach built. The Federal ID tag located inside the coach will show the proper tire size for your coach. When replacing tires, make sure that these guidelines are followed.

Tire Markings

Sample tire size: LT225/75 R 16 E

- LT reflects the "Light Truck" usage. Light truck tires are used on anything from compact pickups to class A motor homes.
- 225 indicates the "contact patch" width. The contact patch is the amount of tire surface that

actually comes into contact with the pavement. In this case the width is 225 millimeters wide.

- 75 indicates the height to width ratio of the tire.
- R identifies the construction type of the tire. R – Radial, B – Bias belted, D – Diagonal Bias. Some tires may have a speed designation label in front of the construction type. Example – MR tires are rated for use up to 81 mph. SR tires up to 112 mph. ZR tires carry the highest speed rating, and are safe for speeds over 150 mph. However, ZR tires should never be installed on any motor home or travel trailer. If no speed rating is listed on the sidewall, the maximum speed for light truck tires is 87 mph, and for passenger cars 105 mph.
- 16 is the rim size. This is the only measurement made in inches.
- E is the load range.

Tire load ratings

Load ratings for tires go up as the corresponding letter changes. For example, load range "E" tires have a heavier rating than load range "D" tires. Load capabilities of tires change as the psi (air pressure) is lowered. As much as 220 lbs. of load carrying capacity is lost per tire for each 5 psi below the recommended inflation. This decreased load amount varies from one tire manufacturer to the next, therefore it is recommended that you contact your tire manufacturer for further information in this regard.

Tire air pressure

When checking air pressures, if the tire has been driven more than 6 miles, you can add 4 to 6 psi to the rated maximum "cold" inflation recommendations. For example, if the tire has a maximum rating of 90 psi cold, you can inflate the tire to 96 psi after being driven on. Under inflation generates excessive heat (a tire's worst enemy!), increases tread wear in the shoulder area, and reduces your vehicle's fuel economy.

Never mix radial, bias belted or bias type tires. Never mix brands. This can adversely affect vehicle handling and stability. Use only the tire size that is listed on the Safety Compliance Certification Label. If you have a question about the label, please call Gulf Stream.

Tire maintenance

When cleaning tires, try to use a tire-cleaning agent. Never use any cleaner that contains solvents. Solvents will draw oil from tires and cause them to prematurely crack. Inspect your tires prior to each trip, looking for bulges or cracks in the sidewalls.

When storing your recreational vehicle for long periods you should completely unload the vehicle so that a minimum weight will be placed on the tires. Make sure the tires are inflated to the recommended operating inflation pressure. Avoid moving the vehicle during extremely cold weather. Move the vehicle at least every three months to prevent ozone cracking in the tire bulge area as well as "flat spotting" from prolonged strain of sidewall and tread deflection. Make sure you check the inflation and adjust to the recommended operating pressure before putting the vehicle back into service.

Emergency Towing of the Motor Home

Extreme care must be taken in the event the unit must be towed as a result of a break down or accident.

NOTE: THE USE OF A "DOLLY" TYPE TOW DEVICE THAT TOWS THE VEHICLE WITH ITS FRONT WHEELS SECURED ON A SMALL PLATFORM FITTED WITH ITS OWN SET OF WHEELS, OR A WHEEL-LIFT TOWING DEVICE THAT CARRIES THE MOTOR HOME'S FRONT WHEELS IN A "CRADLE" OR "SLING" ARE THE ONLY METHODS RECOMMENDED. USING OTHER METHODS MAY CAUSE SEVERE DAMAGE TO THE MOTOR HOME. PLEASE REFER TO YOUR CHASSIS MANUAL FOR FURTHER DETAILS ON TOWING PROCEDURES.

DAY-TO-DAY OPERATION

Driving Techniques

With just a few miles under your belt, you will find that your new GULF STREAM handles much differently than a typical car or truck. You must take into consideration that the vehicle is much longer, higher and heavier than any car or light truck.

Always be mindful of your vehicle's height when approaching underpasses, awnings, parking garages, drive-in facilities (banks, food, fuel) and carport-type overhangs. Remember: your vehicle's height can be different than what the manufacturer lists depending upon any additions you have added to your roof.

NOTE: WHEN APPROACHING AN OVERHANG THAT IS APPROXIMATELY THE SAME HEIGHT AS YOUR UNIT, USE EXTREME CAUTION. PAVEMENT DIPS/RISES AND NEW LAYERS OF ROAD SURFACE CAN MAKE OLD CLEARANCE SIGNS OBSOLETE. "WHEN IN DOUBT...STAY OUT."

Ground Clearance

Just as overhangs can produce problems, so do dips and rises in pavement. Be extremely cautious when

entering and leaving the main roadway (drives, parking lots, side roads, etc.). Become familiar with the rear overhand characteristics of your individual unit. This will help you avoid damage to the undercarriage behind the rear axle. The nature of your unit is such that you will not be able to access as many areas as easily as you would in a car.

Warm weather/high climate operation

Although Gulf Stream vehicles are designed and tested in a variety of hot and cold situations, you must take precautions when driving in hot weather or high climates. Always read your chassis owner's manual section on driving techniques. When driving in hot weather keep your engine speed up, not your road speed. In other words, as the coach slows down, manually downshift the engine. This will keep the engine rpm's up and the coolant flowing at a high rate at all times. On diesel models, by shifting from sixth gear down to fourth gear on uphill climbs you can decrease your engine temperature by up to 15 degrees (depending on humidity and road conditions), and yet you can still maintain 55 mph if your load or the road allows.

Aside from driving habits, always make sure that your radiator is clean of debris and bugs. Using a power washer to clean out your radiator will noticeably increase its cooling capacity. Also make sure that the coolant is a 50/50 mixture of antifreeze/coolant and water. Adding more coolant than water will not increase the cooling capacity of the radiator. Engine coolant is formulated to provide optimum cooling at an equal 50/50 mixture.

Driving in higher elevations (above 5,000 ft) will allow your coolant to boil at a lower temperature.

Driver Controls

Your chassis operator/owner manual will contain most information of driver controls such as Tilt steering, cruise control, dash instruments, transmission gear selection, braking, and other essential driving functions. Please review your chassis manual thoroughly, and familiarize yourself with all chassis controls before your initial trip.

Brakes

As mentioned previously, your vehicle is much larger than an automobile and, though equipped with well-engineered brakes, is likely to take more distance to stop than you have been accustomed to in the past with autos. Learn how quickly your vehicle will stop from your normal cruising speed with the loads you

carry. Become familiar with the amount of pressure that it takes to “lock-up” the brakes in a “panic” stop.

NOTE: EVEN MODERN DISK BRAKES WILL NOT STOP A VEHICLE INSTANTLY IF THEY HAVE BEEN SUBMERGED IN WATER. BE CAREFUL WHEN DRIVING IN FLOODED CONDITIONS. “PRE-DRY” BRAKES PRIOR TO THEIR BEING NEEDED BY LIGHTLY PRESSING DOWN ON THE BRAKE PEDAL AND ENGAGING THE BRAKE PADS AND SHOES TO GET RID OF EXCESS WATER AND WARM THE BRAKING SURFACES. EXTREME CAUTION IS ALSO NEEDED IF ONLY ONE SIDE OF THE VEHICLE’S BRAKING SYSTEM HAS BEEN FLOODED. IF A STOP IS NEEDED THE VEHICLE COULD VEER TO THE SIDE THAT IS DRY (THE BRAKES ON THAT SIDE OF THE VEHICLE ARE WORKING MUCH BETTER THAN THE WET SIDE).

If you notice that the brakes get “mushy”, take your unit to your nearest dealer for inspection. Unusual sounds during braking may indicate a problem. Have your dealer check the braking system. Read your chassis owner’s manual for further information on your particular braking system and its care.

Anti-Lock Braking Systems (ABS)

Vehicles equipped with optional Anti-Locking Brakes have braking characteristics much different than vehicles without. Anti-Lock Brake equipped vehicles have a system that senses wheel movement when braking. While depressing the brake pedal, if wheel movement stops while the speedometer still shows that the vehicle is moving, the Anti-Lock brake system literally “pumps” your brakes hundreds of times per second to allow proper braking. A spinning, braking wheel will stop your vehicle quicker (time and distance) than a skidding wheel. Manually pumping your brakes in this situation will adversely affect the Anti-locking brake system and will actually cause a longer stopping distance than using ABS in the proper manner. Refer to your chassis owner’s manual for ABS braking techniques.

If your ABS dash indicator light illuminates have your vehicle serviced immediately. Call your chassis manufacturer first if you have to operate your vehicle while the ABS dash light is on.

Pac Brakes and Jake Brakes (optional)

Pac brakes and Jake Brakes are sometimes utilized on diesel chassis to limit the engine and transmissions power output for extra assistance in slowing down your coach. Both are good systems and are recommended if you feel you need to supplement your existing braking system to reduce wear. Otherwise, down-shifting the transmission within the vehicle’s limits is the next best way to reduce wear on your brakes (Pac

Brakes and Jake Brakes will down-shift for you). Please contact your chassis manufacturer for further information on these systems.

Dashboard Instruments

While driving, always be attentive to your vehicle’s dash instruments. These instruments are designed to warn you of any problem or potential problem with the vehicle. It is best to stop the vehicle at once if any warning light appears. Reduce your speed immediately by lifting off of the throttle. CHECK THE TRAFFIC BEHIND YOUR UNIT. Don’t apply the brakes too rapidly. SIGNAL YOUR INTENTIONS. Quickly, safely pull off to the side of the roadway onto a safe, solid shoulder area. Make sure the vehicle is out of the flow of traffic as much as possible. Shut down the motor. Place transmission into PARK and apply the PARKING BRAKE. Put on your emergency flashers. Investigate the problem...more than likely under the hood.

NOTE: IT IS A GOOD PRACTICE TO PLACE FLARES AT INTERVALS SEVERAL YARDS BEHIND THE VEHICLE, ESPECIALLY IF YOU HAVE STOPPED AT A HILL, CROSSING OR CURVE. STAND-UP TRIANGULAR REFLECTORS ARE ALSO QUITE WORKABLE. IF THE VEHICLE IS STOPPED JUST OVER THE RISE OF A HILL OR JUST PAST A CURVE, PLACE FLARES OR REFLECTORS OVER OR AROUND THE OBSTACLE TO WARN ON-COMING TRAFFIC IN PLENTY OF TIME FOR THEM TO SLOW DOWN PRIOR TO REACHING YOUR STOPPING POINT.

If a warning light does come on, check under the hood for possible problems. Refer to your chassis operator’s manual for instructions on diagnosing the problem or contacting help.

NOTE: NEVER ATTEMPT TO OPEN A RADIATOR CAP WHEN THE ENGINE IS OVERHEATED OR EVEN AT NORMAL OPERATING TEMPERATURE. THIS WILL RESULT IN AN “EXPLOSION” OF BOILING COOLANT FROM THE RADIATOR OPENING THAT CAN RESULT IN SERIOUS INJURY TO ANYONE STANDING NEARBY.

EXPEDITIOUS USE OF YOUR NOSE WILL OFTEN TELL YOU WHETHER OR NOT YOU HAVE A HEATING PROBLEM. IF YOUR NOSE SAYS “SOMETHING IS COOKING” THEN BELIEVE IT UNTIL YOU PROVE OTHERWISE. EXTREMELY HOT COOLANT HAS A DISTINCTIVE SMELL IF THERE IS A LEAK IN THE SYSTEM. CAREFULLY USE YOUR SENSE OF TOUCH TO SEE IF YOUR COOLANT SYSTEM IS OVERHEATING.























STAY AWAY FROM ANY STEAM ESCAPING FROM SPLIT HOSES, FAILED GASKETS OR LOOSE

CLAMPS. WHEN THE VEHICLE HAS COOLED, THEN ATTEND TO THE PROBLEM.

Unused Dashboard Switch Locations

As a result of the optional equipment available on our extensive line of vehicles, each unit is somewhat different than other units built with the same standard dashboard. Therefore, on some RV models certain dashboard switch locations will not have a switch installed. You may wish to order matching switches from your dealer to use as you add accessories to your coach.

Dash Switch symbols

	Air Horn		Aux. Start
	Back-up Mon.		Cruise
	Cruise		Cruise
	Defroster 2 Speed		Defroster fan
	Defroster fans		Docking lights
	Docking lights		Driving lights
	Fog lights		ICC flash
	Generator pre-heat		Map light
	Generator Start/Stop		Map light
	Radio-Coach/Chassis		Step Cover
	Step Cover		Power Visors

Starting and Vehicle Warm Up

Check your chassis manufacturer's owner's manual for details on starting your vehicle on cold or hot days.

Turbo Diesel Operating Instructions

Turbo charged engines and turbo chargers operate at very high temperatures, which provide the fuel efficiencies, high horsepower, and necessary emission standards. Because of this, the engine must be allowed to build up heat slowly and cool slowly to prevent expansion and contraction of internal engine and turbo charger components. This is accomplished by the following:

Starting

Once the engine starts, return the accelerator pedal to the idle position and let the engine idle for 3 to 5 minutes before applying a load.

Shutting Down

If you have been driving at highway speeds, allow the engine to idle for 3 to 5 minutes before shutting it off. This allows the engine to cool gradually and uniformly.

Jump Starting

If you encounter a dead battery or a low battery and cannot get the vehicle to start on its own, you may need to get a jump start. Before doing this, if your vehicle is equipped with an emergency start switch follow the starting instructions on the switch to try and avoid using jumper cables. Usually, this requires one person to hold the emergency start button in the outside electrical box while the driver attempts to start the engine using the house batteries. If this fails proceed to the following steps:

1. Be sure the jumper cables are in good condition with no exposed wires that may cause a short.
2. If possible, check all batteries for fluid level. BE CAREFUL OF OPEN FLAMES AROUND BATTERY FUMES. THERE IS A CHANCE OF COMBUSTION.
3. Route the cables in such a manner as to avoid all pulleys and engine belts.
4. Set the RV parking brake; place the vehicle's transmission in PARK. Turn off the ignition switch and all electrical items.
5. Use only a 12 volt battery grounded the same as your vehicle (+ or -). DO NOT USE A 24 VOLT SYSTEM TO JUMP START...THIS CAN CAUSE DAMAGE TO YOUR ELECTRICAL SYSTEM.
6. DO NOT LET VEHICLES TOUCH.
7. Attach one end of a cable to the positive (+) terminal of the booster battery and the other end of the same cable to the positive (+) terminal of your vehicle's dead battery.
8. Attach an end of the other cable to the negative (-) terminal of the booster battery and its opposite end to a solid ground in your vehicle's engine compartment at least 18 inches from the dead battery. DO NOT ATTACH IT TO THE NEGATIVE POST OF THE DEAD BATTERY.
9. Start the engine of the vehicle that is providing the boost and turn off all electrical accessories. Now start the vehicle with the dead battery. If the engine in the vehicle with the dead battery does not want to turn over very easily, check the

connections and also see that there is no drain on the electrical system.

10. After the dead battery vehicle has started, carefully disconnect the battery cables, making sure not to get them tangled in the moving parts of the running engines. Disconnect the negative ground contact on the dead battery car first. After the negative cable has been removed from both cars, disconnect the positive terminal on the dead battery car first.

WARNING:

WHEN JUMP STARTING, BE EXTREMELY CAUTIOUS. BATTERIES, UNDER CERTAIN CONDITIONS DURING JUMP START PROCEDURES, CAN EXPLODE, SPREADING BATTERY ACID OVER A WIDE AREA. THIS ACID IS VERY HARMFUL TO HUMANS AND AUTOMOTIVE FINISHES. IF YOU OR ANYONE WITH YOU GETS BATTERY ACID ON THEIR PERSON, FLUSH EXPOSED SKIN/EYES IMMEDIATELY WITH A LARGE AMOUNT OF WATER. SEEK A PHYSICIAN IN MAJOR CASES, AND WHERE THE EYES HAVE BEEN CONTAMINATED. FLUSH ANY RV BODYWORK UNIT THAT COMES INTO CONTACT WITH THE ACID.

EVEN WORKING WITH AN OLDER BATTERY THAT HAS SOME CORROSION ON THE TERMINALS (SUCH AS THE BOOSTER CAR/BATTERIES) CAN GET ENOUGH ACID PARTICLES ON YOUR HANDS TO CAUSE PAIN/IRRITATION. BE SURE NOT TO PUT FINGERS IN EYES, ON FACE OR IN YOUR MOUTH (AS IN PULLING A GLOVE OFF YOUR HAND WITH YOUR TEETH), WASH HANDS EXTREMELY WELL AFTER COMPLETING THE JUMP START.

COACH SYSTEMS

Safety

Your new vehicle has been provided with numerous safety features.

EMERGENCY WINDOW EXIT: Push on bottom red tab. Window will swing out, held in place by top-mounted hinges.

FIRE EXTINGUISHER: Located just inside side entry door. Activated by pulling ring-pin and squeezing handle. Direct contents at base of fire. Read instructions on bottle. Check regularly to insure that charge is adequate.

SMOKE DETECTOR: Located in kitchen/dining area. Sounds alarm if it detects smoke. Test regularly and replace battery as needed. Consult smoke detector owner's manual.

LP GAS DETECTOR: Located in kitchen/dining area near floor. Sounds alarm if it detects LP gas. Test regularly. Consult LP gas detector owner's manual.

CARBON MONOXIDE (CO) DETECTOR: Located in rear hall or sleeping area. Sounds alarm if it detects Carbon Monoxide. Test regularly. Consult CO detector owner's manual.

SAFETY BELTS: Seats that are designated to be used while the vehicle is in motion are equipped with lap/shoulder belts. Flat metal section fits into buckle and locks, giving a distinctive "click." Unlock by pushing in button on buckle.

WARNING/HAZARD FLASHERS: Activated by pushing in/back button on steering column. Parking/turn signal lights flash on and off. Use when stopped for emergency on roadside. Some states have laws against driving with warning flashers on.

EMERGENCY/PARKING BRAKE: Activated by pushing down with foot the lever that is located on the left side of the steering column on gas models. On diesel models pulling out on the yellow air brake knob activates the brake.

NOTE: SOME CHASSIS MANUFACTURERS DO NOT PROVIDE AN EMERGENCY BRAKE OF THIS TYPE. CONSULT CHASSIS OWNER'S MANUAL FOR DIRECTIONS ON HOW TO USE THESE SPECIFIC BRAKE SYSTEMS.

Electrical

Your GULF STREAM is equipped with two (2) separate electrical systems that provide your vehicle with power on the road and in camp.

12-volt DC/110-volt AC

Like all vehicles, it has a 12-volt system that is used for running the vehicle's motor and accessories as well as other added RV equipment that's designed for 12-volt operation. This is a direct current (DC) system (12V).

Like your home, the vehicle has a 110-volt alternating current (AC) system that requires an external source of 110-volt electricity. A shoreline connection (extension cord) or an optional electrical on-board power generator or an inverter can provide this power. In order to use your 110-volt electrical system, your shoreline (power cord) should be plugged into either a properly rated external power source or the generator should be running, or in some cases the inverter should be turned on. **TO CONSERVE BATTERY POWER, USE OF THE SHORELINE IS RECOMMENDED WHENEVER POSSIBLE. (FIG. 5)**

Consult your generator's manufacturer's owner's manual for further details on its use and maintenance.

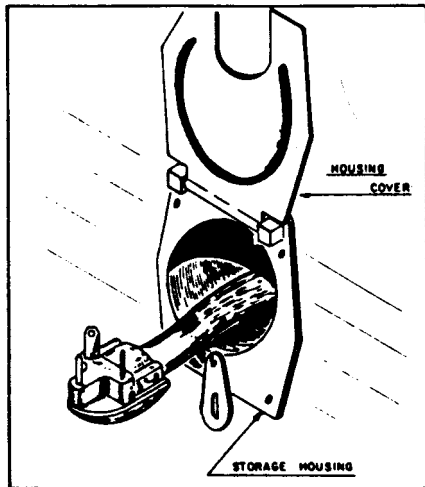

(FIG. 5) 110-V SHORELINE CONNECTION

DO NOT USE A CHEATER PLUG TO HOOK UP YOUR MOTOR HOME TO A 110 VOLT CIRCUIT.

DO NOT USE AN EXTENSION CORD WITH A CURRENT RATING LESS THAN THE AMPERAGE YOUR MOTOR HOME REQUIRES. EXTRA EXTENSION CORDS REDUCE THE AMPERAGE AND VOLTAGE BEING SUPPLIED TO THE RV AND MAY CAUSE DAMAGE TO ELECTRICAL COMPONENTS.

30-Amp and 50-Amp 110-Volt Service

30-amp service is 110-volt service limited to a total of 30 amps of draw. A three pronged power supply cord much like your clothes dryer would have in your house identifies this type of power supply (FIG. 5). Each appliance in your vehicle is capable of working by itself with this type of service. However, you may not be able to operate all your appliances at the same time without causing a circuit breaker to blow.

A typical component in your vehicle such as a TV or VCR will draw only about 1 amp. Other items such as coffee makers and microwaves will draw 10-15 amps when used. Roof air conditioners usually draw the most, pulling up to 15 amps when the compressor is running. So as you can see, with 30 amp service, you can use only one air conditioner when hooked up to shore power even if your coach is equipped with two. The combined draw of two air conditioners may only be 29 amps, but other items in your coach such as converters, refrigerators, water heaters, etc. will put your draw over the 30-amp mark causing a circuit

break. You may be asking yourself "Why then did Gulf Stream install two a/c's if I can only use only one at a time?" This is done so that you can direct more cold air to the front or rear of the vehicle if you desire. Plus, usually they both can be operated while using your generator.

30-amp service is the most common electrical service in the RV industry and can be found at most, if not all, RV campgrounds. This makes 30-amp service the most user friendly as far as availability. If your vehicle is equipped with 50-amp service, you will be able to run any installed appliance at any time when a 50-amp service park is available or you are running your generator.

50-amp service is also 110-volt service, but it is capable of running up to 50-amps of draw. Some people believe that 50-amp service is the same as having 220-volts of ac power. Yes, 50-amps of service does have 220-volts, but only 110-volts is capable of being supplied to any part of your system at any given time. A four pronged power cord that is very unique identifies 50-amp service, as two of the four prongs each carry 110-volts of ac power. 30-amp service has only one prong that carries 110 volts of ac power. Each of the 110-volt lines in a 50-amp cord supplies power to a designated part of your RV. In doing this, when ac powered components are installed they can be put on separate power feeds according to how much amperage they draw. One example of this method consists of installing two air conditioners for use at the same time. Each one is powered by a different power supply feed; therefore they both can be used simultaneously. Think of 50-amp service as having two shoreline power cords in one casing as opposed to only one in 30-amp service.

If you travel to an RV park that does not offer 50-amp service you will have to use an adapter to hook up to shore power. Use of an adapter is not recommended, but may not be avoidable. When using an adapter remember that your coach will not have sufficient power to run as many options as with 50-amp service. You may be able to run both your air conditioners for a limited time; however, this will cause damage to both your ac units as well as other components by operating them on insufficient power.

Listed below are components that might be used in Gulf Stream vehicles and the maximum amperage draw each one has. Whether your power supply is 30-amps or 50-amps this chart may help you decide which components you can safely use for an extended period without damage.

Components	Amperage
Roof air conditioners (each)	15
Electric water heater	12
Microwaves	15
Hair dryer	2
Washer/dryer	10
Vacuum	5
TV	1.0
VCR	1.0
Engine block heater	10
Heart Inverter/Charger	22
Magnetek charger	14
Refrigerators	3.5
Space heaters	10-15
110-volt lamp	1.0

Power Converter

Your vehicle is equipped with an electrical power converter that changes 110-volt power to 12-volt power to run 12-volt powered appliances in your vehicle. It gets the 110-volt power by way of the shoreline or the optional generator. The power converter will be located either under the side of the rear bed or under the refrigerator (FIG. 6).

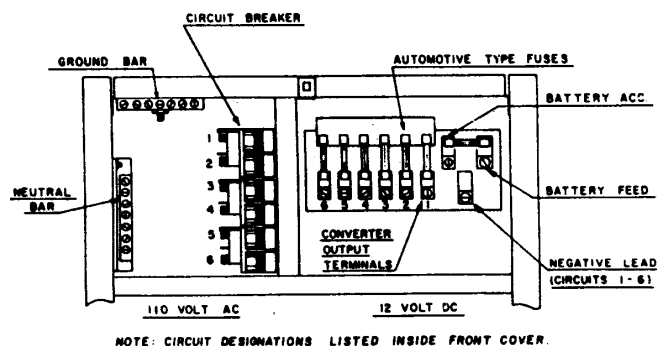

(FIG. 6) 45 AMP CONVERTER PANEL

The circuits in the vehicle are protected by circuit breakers and fuses. Locate the converter and see where the fuses are located. If you blow a fuse, turn off the appliance. Unplug the fuse. Check the fuse for breakage and replace it with a new fuse of the proper rating. If the fuse continues to fail, contact your nearest dealer. NEVER REPLACE A FUSE WITH A HIGHER RATED FUSE THAN WHAT IS DESIGNATED.

Ground Fault Interrupter

Your unit is equipped with a Ground Fault Interrupter that will stop the current in the event of a short. Refer to your manufacturer's owner's manual on how to reset the GFI (FIG. 8)

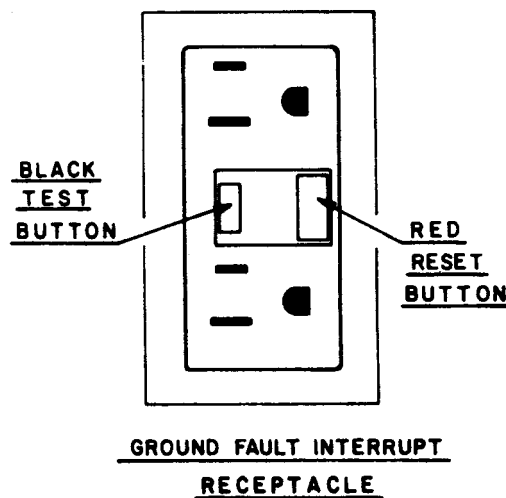

(FIG. 8) GFI RECEPTACLE

Automotive 12-volt system

The vehicle's alternator provides power to charge both the automotive 12-volt battery and the coach "house" batteries. An isolator relay system prevents the RV battery from draining the automotive battery.

Review the isolator relay system manufacturer's owner's manual for specific information on this system. The automotive battery provides power to start and run the vehicle's ignitions system and various automotive lights and accessories.

The alternator charges the RV battery that, in turn, powers all the appliances and equipment in the "house" portion of the vehicle that use 12-volts. These include the furnace blower, refrigerator, water heater ignition, and the water pump. The RV battery is charged through the power converter whenever the vehicle is using a shoreline connection or when a generator is used. The Chassis battery is only charged when the vehicle is running.

NOTE: KEEP IN MIND WHAT APPLIANCES/EQUIPMENT YOU HAVE TURNED ON WHEN YOU ARE WORKING OFF THE RV BATTERY ALONE. SOME EQUIPMENT DRAINS POWER AT A MUCH GREATER RATE THAN OTHERS

Battery

As noted above, the unit has two or more batteries on board. Both are maintained in the same manner. Check the electrolyte fluid levels on a regular basis, especially during hot weather conditions. Refill as necessary with either distilled water or clean tap water in an emergency. **DO NOT ALLOW THE FLUID LEVELS IN THE BATTERIES TO FALL BELOW THE INTERNAL BATTERY PLATES. DAMAGE TO THE BATTERIES MAY RESULT AND SHORTEN THE LIFE OF THE BATTERIES.**

When charging the batteries, do not charge at such a fast rate as to cause spewing of the electrolyte from the cells. However, do charge the battery with the cell vent caps off.

WARNING:

NEVER USE AN OPEN FLAME AROUND BATTERIES. AVOID MAKING ELECTRICAL SPARKS. FUMES FROM THE BATTERY ARE COMBUSTABLE.

KEEP AN EYE OUT FOR CORROSION ON THE BATTERY TERMINALS. CORRODED TERMINALS CAN CAUSE A LOSS OF AVAILABLE POWER AS WELL AS CUT DOWN ON THE EFFICIENCY OF THE CHARGING/ELECTRICAL SYSTEM. THIS COULD LEAD TO A SITUATION WHERE THE BATTERY ISN'T CHARGED ENOUGH TO START THE VEHICLE...THE DRAIN ON THE BATTERY WAS GREATER THAN THE CHARGE TO THE BATTERY DUE TO DIRTY TERMINAL CONNECTIONS.

If your batteries have problems prior to the end of their warranty period, consult the nearest representative of the battery manufacturer.

When it is time to replace the batteries, be sure to replace them with quality batteries of equal electrical and physical properties. Contact your nearest dealer for advice in the selection of new batteries.

Battery Types and Charging

Only similar batteries should be connected together in one bank. Do not connect old and new batteries, or wet and gel cell batteries together. Deep-cycle batteries are usually rated in Amp-hours, which is based on a 20-hour discharge rate. Therefore, a 100 amp-hour battery can deliver 5 amps for 20 hours. Deep-cycle batteries can be discharged about 80% of capacity before damage occurs. Shallow cycling (50%-60% drain before recharge) will result in much longer battery life. To find out how long your batteries will last when using various equipment in your coach, research the amperage of the items in use, and use that number to gauge what size amp-hour battery you

think you need. Keep in mind that you should recharge your batteries when they are 50% discharged, so only half of the amp-hour rating is actually used.

Completely charging wet cell deep-cycle batteries requires the battery voltage to be raised beyond what is known as the gassing point. This is the voltage at which the battery begins to bubble and gas is given off. If charging stops short of this point, sulfate is left on the plates and deterioration of the battery begins. The gassing point will vary with battery temperature. At 77 degrees F, the gassing point of a 12-volt battery is about 14.0 volts.

On-Board Auxiliary Power Generator (Optional)

This unit provides 110-volt power to the converter as well as charges the RV battery. Read over the manufacturer's owner's manual for the unit's operation and care/maintenance.

The unit runs on gasoline, LP gas, or diesel fuel depending on your chassis and the model generator selected. **BE SURE TO CHECK THE OIL LEVEL OF THE GENERATOR AT REGULAR INTERVALS.**

Inverter

Inverters are much like converters, only they perform the exact opposite functions. Inverters take 12-volt DC battery power and invert it to 110-volt AC power. Using the inverter can drain a fully charged battery in as little as two (2) hours, depending on what appliances are being used. Therefore, inverters are usually used sparingly.

The inverter switch should remain in the "off" position on the inside panel, unless using the inverter mode. The inverter/converter will still charge your batteries when in the "off" position and the coach has 110 volt shore power. If the switch is left on, as soon as you unplug the coach you will start draining your batteries. Also, if for some reason you lose your shoreline power source without your knowledge, the inverter will automatically take over and after a few hours your batteries could be completely drained.

When batteries are drained this low it takes at least 24 hours of slow charging to bring them back to a "charged" status.

The inverter is installed as a temporary means of supplying 110 volt power. You can watch TV for several hours, or run small appliances for a short period of time. Appliances with heating elements (ceramic heaters, blow dryers, curling irons, clothes irons, etc.) will drastically shorten the amount of power supply from the batteries. The inverter and battery

bank is not designed to sustain the coach for long periods of time.

If you have the inside control panel option, leave the exterior switch located on the inverter in the “off” position at all times.

Check your inverter operator’s manual for proper use of the inverter.

Monitor Panel

Your vehicle has an electrical panel that can provide you with important information about various systems on the RV including the condition of your batteries.

The panel is most often located above the stove or on the wall near the stove. The monitor panel will give you information including:

- How much potable (fresh) water remains.
- How full your black (sewage) tank is.
- How full your gray (waste water) tank is.
- How much LP gas is in your LP tank.
- How much charge your chassis and house battery have.

Solar Charger

Some motor homes come factory equipped with an optional solar charger. The solar charger is a low amperage charger for your house battery. The solar charger is operating when the red indicator light comes on. The red indicator light will be located on the base of the roof air conditioner or near the monitor panel near the driver’s seat. Good exterior lighting is necessary for the solar charger to operate.

Television Electrical Connection

A television “cigarette lighter” type DC electrical outlet is located in your vehicle. For example, on some units it is located both in the front and rear near shelving specifically built for holding TV’s. THIS “CIGARETTE LIGHTER” OUTLET IS INTENDED FOR TELEVISION USE ONLY. ANY OTHER USE MIGHT CAUSE AN ELECTRICAL PROBLEM OR A POSSIBLE ELECTRICAL FIRE. USE ONLY THE PROPER “CIGARETTE LIGHTER” ADAPTER DESIGNED FOR YOUR SPECIFIC TELEVISION.

This panel may also contain a television 75 ohm RF antenna hookup.

TV Antenna and Cable Connections

Usually each coach is equipped with two (2) signals to choose from (newer models may have three due to

mini-dishes). The two most common signals include the roof-top antenna and the external cable source.

In the cable system the most important part is the selector box. All signals come from and go to this box. The box is passive, and requires no electricity to operate. Most new “A” models have this box(FIG. 10).

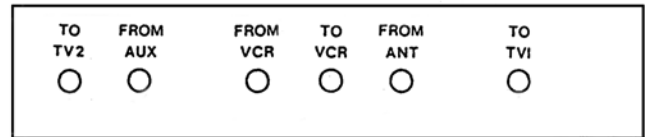

(FIG. 10) VIDEO CONTROL BOX

The cable that carries the signal is called a “coax” cable. The cable is black and about as thick as an inexpensive ball point pen. The cable consists of one solid copper signal line, surrounded then be an insulation core, which is wrapped with a stranded ground wire shield and finally the exterior black cover. Its very important to make sure that the grounded strand wire does not come into contact with the solid copper wire, as this will adversely effect your reception. Also make sure that when using a satellite system the cable used is RG-6 cable. The coax cable commonly used for cable tv systems is insufficient for satellite systems.

If you have a bad reception, perform the following checks:

- Check with neighbors to see how good local cable and antenna reception has been.
- Make sure selector switch is set properly.
- Turn the antenna booster on.
- Set your TV to receive “Air” or “Cable”, whichever signal you are watching.
- Check all cable ends to make sure that no ground strands are touching the center cable wire.

If you have no reception at all, perform the following checks:

- Follow all steps above.
- Some units have a cable splice in the back of the refer cabinet. Access this splice from outside and make sure the connection has not been compromised.
- Use a continuity tester to ensure that all cables are hooked up properly.
- Contact your local service center or park manager for assistance.

LP GAS

General

The liquid Petroleum gas system in your unit furnishes fuel for various appliances. It is comprised of propane (LP) gas. LP gas provides an efficient and inexpensive source of energy.

The gas is stored in a pressure tank located on or under the chassis of your unit. Under pressure, the LP gas turns to vapor; it is this vapor that burns.

Each tank has an automatic eighty percent stop-fill valve that allows space in the tank for vapor expansion. The high pressure of the vapor in the tank is reduced in two stages as it makes its way to your appliance. The tank pressure will vary with temperature and altitude, but it may be in the range of 100 to 250 pounds per square inch (psi) or more. It is reduced by a pressure regulator to about 12 psi in the first stage and then to about 6.25 ounces in the second stage. The 6.25 ounces psi can also be expressed as 11 inches of water column.

The LP gas system is designed and built to rigid standards and tested before leaving the factory. Your dealer also tests the system prior to customer delivery.

NOTE: YOUR DEALER IS RESPONSIBLE FOR A THOROUGH LP GAS SYSTEM CHECK PRIOR TO DELIVERY. DO NOT ACCEPT THE UNIT UNTIL THIS CHECK HAS BEEN COMPLETED.

Except for simple maintenance and occasionally tightening a connection, you should take your unit to an authorized dealer for LP gas problems. The LP gas tank should always be filled by an authorized LP supplier.

NOTE: YOUR UNIT'S MANUFACTURER IS NOT RESPONSIBLE FOR PERSONAL INJURY OR PROPERTY DAMAGE RESULTING FROM IMPROPERLY MAINTAINED LP GAS APPLIANCES AND SYSTEMS.

CAUTIONS: READ LP GAS PRECAUTIONS IN THE FRONT OF THIS MANUAL. BECOME FAMILIAR WITH THEM AND MAKE SURE YOUR ENTIRE FAMILY IS COMPLETELY AWARE OF THE SAFETY ASPECTS OF LIVING AROUND LP GAS.

Climate Differences

The appliances in your vehicle will not function if the LP gas does not vaporize. Propane will continue to vaporize down to -44 degrees F.

Propane has become the main type of LP gas used in RVs in recent years. Butane should not be used. The LP gas dealer will have the correct type or blend for his locale. If you plan on traveling from a warm climate to a cold climate, check with your local gas dealer to see

if the blend he supplies is appropriate for the part of the county you plan on visiting.

Operation

To operate any LP gas appliance, the LP gas tank's service valve must be OPEN (FIG 11). When first used, or after a refill, there may be some air in the gas lines that will escape when the range burner or similar gas valve is opened. The air may extinguish the match or igniter the first time or two you attempt to light a stove burner.

Also remember that when you close the tank's service valve, some gas will remain in the lines. To completely bleed the lines of gas, close the tank valve and light the range burner. When the flame burns out, turn off the appliance.

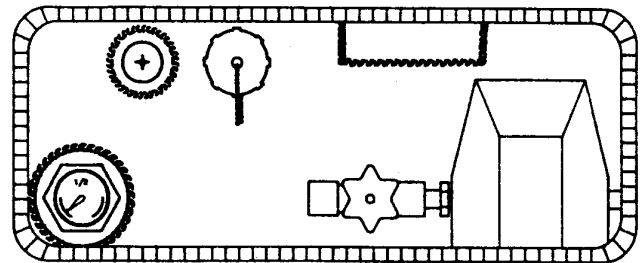

(FIG 11). LP GAS TANK

Filling the LP tank

Make sure that all burners and pilot lights are turned OFF prior to having a gas supplier refill your LP tank.

Drive your unit to the LP supplier for filling. Never remove the tank from the unit. The supplier will connect his fill nozzle to your unit's LP tank FILL VALVE.

When the tank is being filled, the service valve must be CLOSED. The 20 percent LIQUID LEVEL GAUGE must be OPEN.

The 80 percent STOP FILL VALVE may close the valve before liquid appears at the 20 percent liquid level gauge, but if liquid does appear, stop filling immediately...the tank is filled to its LP capacity.

Do not use a wrench to tighten the service valve or the 20 percent gauge. They are both designed to be closed leak-tight by hand. If you cannot hand-tighten the valve, the valve may need repair or replacement. Consult your gas dealer.

YOUR LP TANK MUST BE KEPT FREE OF RUST AT ALL TIMES. IF RUST DOES DEVELOP, THE TANK SHOULD BE CLEANED COMPLETELY FREE OF THE RUST, PRIMED, AND PAINTED WHITE (OR SOME OTHER HIGHLY REFLECTIVE COLOR) WHICH WILL HELP TO REDUCE EXPANSION OF THE LP GAS BECAUSE OF HEAT.

Gas Line Check

Check the gas line connection and all other connections regularly. To check, turn OFF all burners and pilot lights. Open all doors and windows. OPEN the LP gas tank service valve and use soapy water or an approved leak detector fluid to test all line connections. Do not use products that contain AMMONIA or CHLORINE. The appearance of bubbles in the soapy solution indicates a leak. Tighten the connections with two (2) open-end wrenches until the bubbles stop. If this does not take care of the leak, contact your gas dealer. DO NOT OVERTIGHTEN. (FIG. 12)

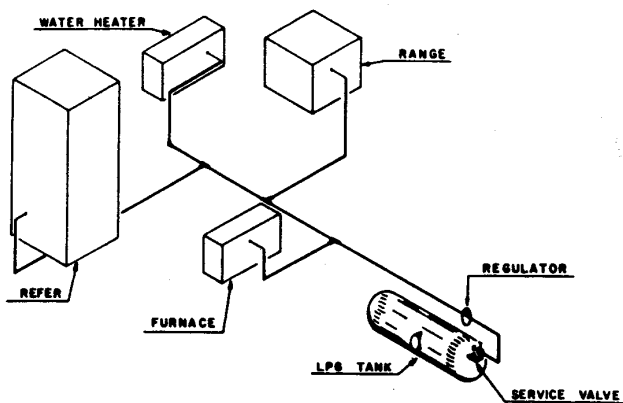

(FIG. 12) LP GAS SYSTEM (TYPICAL)

Regulator Pressure

Have the gas regulator checked at the beginning of each season and whenever a problem occurs. Proper line pressure is 11 inches of water column. Your RV dealer or gas supplier can perform this needed check.

Gas Tank and Regulator Freeze-Up

LP gas regulator freeze-up can be prevented if owners are aware of its causes. Freeze-up may be caused by one of these things: moisture in the tank, an overfilled tank or a greater vapor withdrawal demand than the tank can deliver at a particular temperature.

Freeze-up occurs more frequently in cold weather since liquid gas does not vaporize as quickly. This, along with a higher demand, can cause frosting of the tank and regulator. Be sure to have your LP gas supplier add ANHYDROUS METHANOL before filling the tank in cold weather.

Moisture may enter the tank in the LP gas through condensation if air is allowed to enter the tank through an open valve. This can be avoided by using moisture-free gas and keeping all tank valves CLOSED during

storage. If moisture is present, have the tank purged by an authorized dealer and have him add the proper amount of ANHYDROUS METHANOL for your tank.

An overfilled tank can allow liquid gas, rather than the needed vapor, to flow through the regulator. This can result in erratic regulator delivery pressure, improper appliance operation and possible frosting of the regulator and gas line. This can be avoided by following the procedures outlined in "Filling the LP Tank." Always contact your local gas supplier for current procedures.

Hose Replacement

The flexible LP gas hoses connected to your LP tank should be checked regularly for signs of deterioration and may need to be replaced every two to three years. Be sure to replace the hoses with approved and properly rated products.

Regulator Vent Maintenance

Since the LP gas regulator is equipped with a vent that allows the system to "breathe," you must check it on a routine basis to see that it does not become clogged. If dirt, sealant or corrosion clogs the vent, clean it with a toothbrush or similar device. At least once a year have your LP serviceman check the regulator for adjustment and operation.

PLUMBING

Fresh Water

Fresh water for your RV is provided by filling the FRESH WATER TANK or by hooking directly to a city water connection. These sources supply water to the kitchen sink, shower, lavatory, toilet and water heater. (FIG. 13)

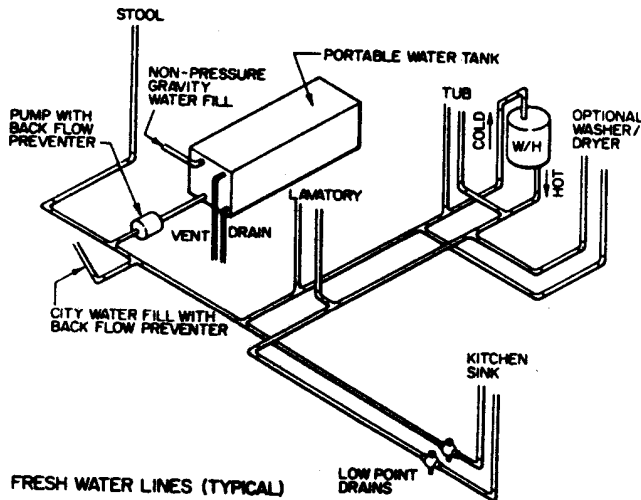

(FIG. 13) FRESH WATER LINES (TYPICAL)

City Water

Open the CITY WATER INLET DOOR and connect a hose to a city pressurized water faucet and to the vehicle's CITY WATER INLET. Some models have a separate water fill for the FRESH WATER TANK. Others have a selector switch to select either LOCAL SUPPLY or FRESH WATER TANK. To use CITY WATER make sure the selector is set to LOCAL SUPPLY. The fresh water tank and water pump are by-passed when the city water hook-up is used.

CAUTION: A PRESSURE REGULATOR SHOULD ALWAYS BE USED WHEN CONNECTING TO CITY WATER. EXCESSIVE WATER PRESSURE CAN DAMAGE LINES AND CONNECTIONS, CAUSING WATER DAMAGE TO YOUR RV. MAKE SURE WATER PRESSURE NEVER EXCEEDS 60 PSI.

Water Tank

UNLOCK the GRAVITY WATER FILL HATCH and use a hose or vessel to fill the water tank. Or, select FRESH WATER TANK after hooking the hose to the CITY WATER. Watch your monitor panel inside to determine when the tank is full.

CAUTION: NEVER LEAVE YOUR COACH UNATTENDED WITH FILLING THE FRESH WATER

TANK! ALTHOUGH PROPER VENTING IS ALLOWED FOR OVERFLOW, THE WATER PRESSURE CAN EXPAND THE TANK AND CAUSE STRUCTURAL DAMAGE.

Use only fresh, potable water in the storage tank. To insure that the tank is clean, drain after each trip. Sanitize the tank when new, whenever contamination is suspected, or whenever it has not been used for a long period of time.

Quick Fill water supply

Some coaches come equipped with a Quick Fill water supply (FIG 13A) connection for supplying local water and filling the water holding tank. With this system, to fill the water tank connect the water supply hose to the female water hose fitting located inside the waste holding tank compartment. Select "fill" on the blue Quick Fill lever, which may be located on the opposite side of the coach, and turn on the water supply. Watch the inside monitor until the water tank reads full. If the water fill is left unattended, excess water will escape out the overflow valve located on top of the water tank. This method of topping off the tank should be avoided.

To select local water supply, simply turn the blue Quick Fill selector lever to the "local supply" position.

Selector Valve

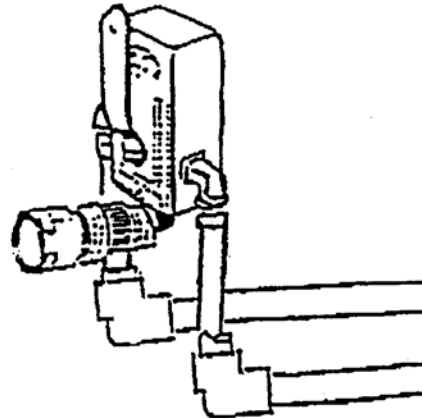

(FIG 13A) QUICK FILL WATER SUPPLY LEVER

Sanitizing the Water Tank

To drain, OPEN the WATER TANK VALVE (FIG. 14). When the tank is empty, CLOSE the valve. Mix three (3) gallons of water with three-quarters cup of LIQUID HOUSEHOLD BLEACH. Pour this solution into the tank through the GRAVITY FILL. Or, siphon from the winterizing tube supplied on some models. Wait three hours, drain and flush several times with fresh drinking water.

Water Pump

The RV water pump is a 12-volt DC appliance that is activated by a switch in the kitchen area or on the monitor panel. The switch may be left ON while camping. This is called a demand system. (FIG. 14)

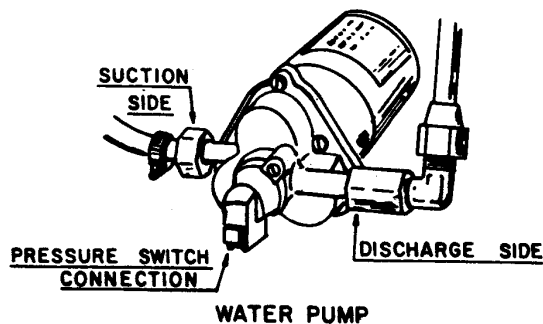

(FIG. 14) WATER PUMP

Turn the faucet on when you want water. The pump will run only as long as needed. If the pump fails when the switch is ON, check the fuse located in the converter. If the pump continues to operate whether the faucet is open or closed, check the water tank to see if it is empty and check to see if there is a leak in the system.

DO NOT RUN THE WATER PUMP WITHOUT WATER IN THE SYSTEM. ALWAYS KEEP THE PUMP SWITCH OFF WHEN THE SYSTEM IS EMPTY OR WHEN CONNECTED TO CITY WATER. RUNNING THE PUMP DRY CAN DAMAGE IT AND VOID THE WARRANTY.

Secondary water pump switch

Some vehicle models have a second water pump switch located in the bathroom near the lav sink. This switch will turn on the water pump whether the main water pump switch is on or off.

Winterizing the Water Pump

With the water drained from the potable water tank, disconnect the water pump outlet hose and then turn the pump on to allow the remaining water to be pumped out (less than one cup).

If you desire, you can blow out the water lines with compressed air by opening all valves and placing the air nozzle into the system where the outlet hose has disconnected. Replace pump hose.

Water manifold system (USA only)

The water manifold system directs a separate hot and cold water line to each fixture in the RV. Therefore, if you wish to change your kitchen sink faucet, you need only to shut off the supply lines labeled "Kitchen sink." This will allow water supply to all other fixtures during service or replacement.

The water manifold is located in an exterior compartment. To activate water on a specific valve, use the provided key and turn the lever until it is lined up with the indicated arrows (left/right). To shut off water supply to a specific line, turn the key ¼ turn in either direction (up/down). Note that both the hot and cold lines must be turned off for removal of plumbing fixtures.

Winterizing bypass on water manifold

The water manifold is designed to also act as a bypass for the water heater when winterizing the coach. To bypass the water heater, turn the cold #9 valve off, and the hot #9 valve on.

Drainage and Sewer

Your RV has a Drainage/Sewer system that operates much the same way as the one in your home. How extensive the system depends on your unit model and the options you obtained. It includes a drain line from the kitchen sink and shower to a GRAY WATER HOLDING TANK. There is also a marine toilet and lavatory that empties into a separate BLACK WATER HOLDING TANK. Which tank each sink drains into may vary from one model to another.

The drainage system also includes vents that carry odors caused by drain water and waste out of the RV, while also equalizing air pressure. Drain clean outs are provided to clean lines between fixtures and holding tanks.

Drainage P-traps

By code, all drains are equipped with P-traps to keep holding tank odors from entering the vehicle. If you detect a foul odor, which you believe is from your holding tanks, add water to all drains to ensure that your P-traps water hasn't evaporated from long term storage. Places to add water include the Kitchen sink, Bathroom sink, shower/tub, wet bar sink, and the washer/dryer drain.

Holding Tanks

Your unit has a GRAY WATER HOLDING TANK and a BLACK WATER HOLDING TANK. The tanks should be emptied frequently, or as indicated on the monitor panel. The tanks should always be emptied at a special DUMPING STATION. Most campgrounds and highway rest stops and many gasoline stations are equipped with proper DUMPING STATIONS.

NOTE: MOST STATES HAVE LAWS PROHIBITING EMPTYING SEWAGE ANYWHERE BUT AN APPROVED DUMPING STATION.

While camping it is normal practice to leave your GRAY WATER HOLDING TANK valve open if your campsite is equipped with sewer hook-up. NEVER leave the BLACK WATER TANK valve open while using the coach. Since the system utilizes gravity to empty, the BLACK WATER TANK will not drain properly unless it has sufficient liquid to help drain out the solids.

Emptying Holding Tanks

To empty the holding tanks, be certain that your RV is level since this process depends upon gravity. Remove the sewage drain hose from its storage location. Remove the cap from the termination outlet and connect the drain hose (FIG. 15).

NOTE: DRAIN THE TOILET (BLACK) HOLDING TANK FIRST.

To drain either holding tank, pull out the TERMINATION VALVE (FIG. 15) by pulling out the dump valve slide handle. Close the valve after the tank has drained. Flush or pour about two gallons of water through the toilet when emptying the black tank and drain again. This flushes the tank and helps clean the drain hose. Repeat as necessary.

Follow the same procedure for the GRAY WATER HOLDING TANK. A repeat flush is not necessary. When the tank is empty, push the dump valve handle in until it seats. Remove the hose, wash and replace it in its storage location. Replace termination outlet cap.

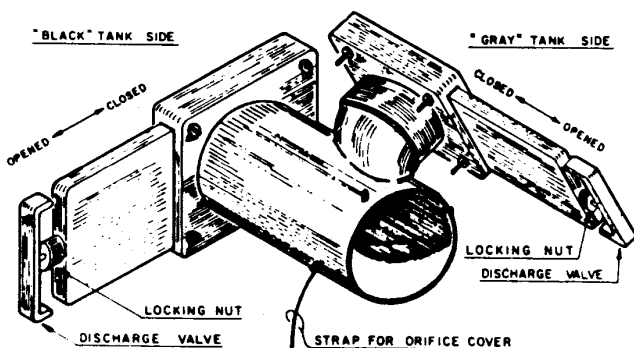

(FIG. 15) TERMINATION VALVES

Holding Tank Maintenance

Keep your tanks well flushed out when the vehicle is not in use. Allowing the tank to sit with any contents for more than a couple of days will ensure some sort of build-up on the monitor probes in the side of the tank and future monitor reading problems, even if this is the first time you have used your RV. One way to help flush them out is to drain them at the campground, then fill each tank half full of water for the trip home. The constant agitation while driving home usually does a good job of cleaning the tanks. Then, before you arrive at home, stop at a local approved dumping station and drain the tanks completely.

When camping there are a few things you can do to help facilitate the cleaning process later. First, you should always use some type of chemical additive in your holding tanks specifically designed for RV use. These types of chemicals will break down the contents of the tanks and help ensure good drainage. In addition, try using tissue designed for recreational vehicles. It will break down more than residential style tissues, and usually never clogs your drain valves.

Do's and Don't of Holding Tank Use

- DO** Clean the holding tank with an approved cleaner.
- DO** Add a special chemical additive to sanitize and improve tank action.
- DO** Guard the tank against Freeze-up.
- DO** Keep the dump valves closed to allow the tanks to get as full as possible to facilitate drainage.
- DO** Keep the dump valve closed and the drain cap in place to allow the use of the system when not parked at a campsite.
- DON'T** Put Facial tissues, paper, automotive type anti-freeze, sanitary napkins, diapers or household toilet cleaners in your holding tank.
- DON'T** Put foreign objects in the system that could clog or damage it in any way.
- DON'T** Use the toilet while driving down the road. All occupants must remain seated with a secure seatbelt while the vehicle is moving. Further, the vacuum caused by the high-speed movement of the vehicle will cause the toilet to act as a vent when flushed, causing severe odors in the vehicle.

Holding Tank Flush system (optional)

The optional holding tank flush kit is installed on the gray and black water holding tank system. To use this system, connect a water hose to the flush kit hose located inside the holding tank dump valve

compartment. Note that the lever used on this system is not an “on/off” lever, but rather a selector for which tank you wish to flush. After connecting your water hose, turn on the water to begin flushing your tank. For best results leave the dump valves closed until you have flushed each tank. Do not leave the flush system unattended, unless you decide to leave your dump valves open.

The optional glass container on the flush system hose is used to house a sanitation tablet for sanitizing each tank. Tablets are available at most RV dealers or RV parts stores.

Water System Winterizing

NOTE: READ THIS BEFORE WINTERIZING YOUR WATER SYSTEM.

If your RV is going to be stored unheated in temperatures that **COULD GO BELOW FREEZING**, the fresh water and waste systems must be winterized.

Follow this procedure:

1. Drain the fresh water tank.
2. Drain pipes by turning the water pump ON and opening a cold water faucet. Wait for the water flow to stop. Turn pump OFF. Leave faucets OPEN.
3. Turn ON all faucets and OPEN the HOT and COLD WATER PIPE DRAIN VALVES. Leave these valves in the OPEN position. These valves are located either under the galley sink or in an exterior compartment, and permit the water to drain onto the ground below the RV.
4. OPEN the WATER HEATER drain valve located at the bottom of the heater (or remove plug). Let the water drain out. OPEN the heater SAFETY VALVE.
5. Flush the toilet.
6. After each faucet has been opened, drained and closed, CLOSE the WATER LINE DRAIN VALVES.
7. Drain the WASTE WATER HOLDING TANK.
8. Double check that ALL WATER has been drained.
9. Secure all protective caps including the water tank filler, city water inlet and waste drain outlet.

CAUTION: DRAINING THE WATER SYSTEM ALONE MAY NOT BE ENOUGH TO PROVIDE COMPLETE COLD WEATHER PROTECTION FOR AN RV UNIT THAT WILL BE STORED IN AN UNHEATED ENVIRONMENT WHERE TEMPERATURES DROP BELOW FREEZING. CONSULT YOUR DEALER FOR MORE INFORMATION ON THE BEST METHOD OF WINTERIZING YOUR VEHICLE.

Units equipped with a winterization siphon hose should use it to pump RV anti-freeze into the plumbing system.

Always pour a cupful of RV anti-freeze into each drain after your coach has been winterized.

Some people may choose to remove water from the plumbing system by using air pressure. If you choose to do this make sure that the air pressure never exceeds 60 psi.

WARNING: DO NOT USE AUTOMOTIVE ANTI-FREEZE OR WINDSHIELD WASHER FLUID ANTI-FREEZE IN THE MOTOR HOME WATER SYSTEM. THESE CAN BE HARMFUL OR FATAL IF SWALLOWED. YOUR DEALER CAN PROVIDE YOU WITH SPECIAL ANTI-FREEZE THAT IS SAFE AND APPROVED FOR RV WATER SYSTEMS. ALWAYS FOLLOW MANUFACTURER'S INSTRUCTIONS FOR THESE ADDITIVES.

APPLIANCES

WARNING:

THE HOT WATER HEATER AND FURNACE USE LP GAS AS FUEL, AND IN THE COURSE OF NORMAL OPERATION HAVE PARTS/SURFACES THAT BECOME VERY HOT AND ALSO EMIT COMBUSTION GASES. BE CAREFUL TO ALWAYS FOLLOW MANUFACTURER'S RECOMMENDATIONS ON VENTILATION AND DO NOT TOUCH THE AIR EXHAUST PORTS OR ALLOW ANY MATERIAL TO COVER THEM OR EVEN COME IN CONTACT WITH EITHER THE INTAKE OR EXHAUST OF THESE APPLIANCES.

WHENEVER YOU OR SOMEONE IN YOUR VEHICLE SMELLS LP GAS, TAKE PRECAUTIONS AS OUTLINED EARLIER IN THIS MANUAL.

Water Heater

NEVER IGNITE THE HOT WATER HEATER WITHOUT FIRST FILLING IT WITH WATER.

The water heater is accessed by a panel on the outside of the vehicle (FIG. 18). Turn on the hot water faucet at the galley sink to see if the tank is full. Operating instructions can be found in the manufacturer's owner's manual.

NOTE: ONLY QUALIFIED TECHNICIANS SHOULD PERFORM SERVICE ON THE WATER HEATER. IF NOT SERVICED PROPERLY A FIRE COULD OCCUR.

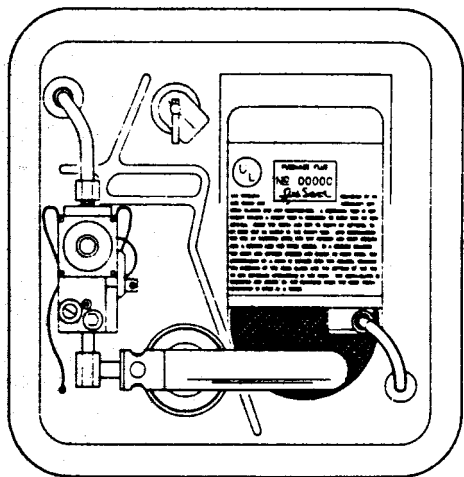

(FIG. 18) WATER HEATER

Range

Also operated with LP gas are the range burners and the oven. The basic operation is the same as the units in your home except that extra care must be taken to provide adequate ventilation in your RV. Unlike your home, the RV has limited air space, thus, a limited amount of oxygen available for combustion.

WARNING: DO NOT USE OPEN FLAMES, SUCH AS THE RANGE BURNERS, TO WARM THE LIVING AREA OF THE RV. THE FLAMES CONSUME THE OXYGEN IN THE VEHICLE AND COULD RESULT IN ASPHYXIATION.

Always provide adequate ventilation when using the range and oven. It is always best to use the range exhaust hood and open a window slightly.

Your owner's packet contains owner's manuals for the oven and range. Read these over carefully to become familiar with the safe operation of these appliances.

Microwave

The optional microwave is no different than that found in your home. It relies on 110-volt power for operation and should never be used while driving down the road. Read over the microwave oven's owner's manual to find all the information on its operation and cleaning.

Refrigerator

Unlike your home refrigerator, the unit on your RV can be operated on LP gas and 120-volt AC electricity. Read over the owner's manual provided in your owner's packet before putting the refrigerator into operation.

The refrigerator will not operate correctly if the vehicle is not level while parked. The refrigerator coolant will not circulate properly if the unit is not level.

For best results, make sure the outside sidewall vent and roof vent are always clear of debris. Without proper circulation of the rear coils the unit will not keep food cold.

Upon initial operation, or after being stored, the refrigerator it could take up to 24 hours before the unit is cool enough for use.

Furnace

Your RV is equipped with a forced-air furnace similar to the type found in most homes with the exception that it is fueled by LP gas. Each unit is equipped with a wall mounted thermostat that controls the temperature. An operating manual for the furnace is included in your owner's packet.

The furnace is designed to have un-obstructed airflow from all its vents, including interior and exterior. If any vent is blocked the furnace may shut itself off.

The furnace igniter is powered by your 12-volt battery system. If the system battery is low the furnace blower will come on, however the furnace will not ignite. Make sure you have sufficient battery power before operating the furnace.

Your furnace is designed to sustain a desired temperature in the vehicle at most times. Due to varying weather conditions, the furnace may not be able to keep up with sub-freezing temperatures. The amount of vehicle occupants and the position the vehicle is parked may help or hinder the furnace's ability to keep up with freeze conditions. Consult the furnace owner's manual for more information.

WARNING: DO NOT SUPPLEMENT THE FURNACE WITH ANY PORTABLE FUEL-BURNING APPLIANCE FOR HEATING THE INTERIOR OF THE MOTOR HOME. THESE APPLIANCES ARE NOT SAFE; ASPHYXIATION/CARBON MONOXIDE POISONING IS POSSIBLE IN ANY SMALL, WELL-SEALED SPACE.

Air Conditioner (roof)

Many motor homes are equipped with a roof air conditioning system that works with electrical power from either a shore line or a portable generator.

Air conditioners are capable of cooling air a maximum of 18 to 22 degrees in a 50% humidity environment. As the humidity goes up, the cooling difference goes down. If the temperature inside your coach is 100 degrees when you turn on the air conditioner, it will only put out 80 degrees. Eventually the air inside the coach will cool, and as it cools the air put out by the air conditioner will cool also. However, when starting out at 100 degrees, this cooling could take several hours before it reaches your desired temperature. Therefore, if you know the weather will be hot, turn your air conditioner on early.

The two most common complaints with roof air conditioners are they won't turn on at all, or when they do turn on, they won't put out cold air. Obviously, if the unit won't turn on you may have a problem with something other than the air conditioner. Always make sure you have sufficient power to run each air conditioner you plan on using. If your power source has only 30-amp service, you can run only one (1) air conditioner at a time. Using an adapter to plug in your 50-amp cord to 30-amp service doesn't allow the use of both AC's either. Most AC's require a minimum of 13 amps to operate properly. Although the amperage of two AC's running at the same time doesn't add up to 30 amps, other components in the coach, such as the converter, refrigerator, VCR (draws amps simply by just being plugged in), etc., draw enough amperage to push the total amp load over the 30 amp mark. If you desire to run both AC's in a 30-amp environment, try running your generator instead of using shore power. Run both AC's off the generator until the coach cools off, then use shore power to run only one AC, which by itself will usually maintain a cool temperature inside the coach.

Fantastic Fan Operation

The ceiling fan used in your coach is designed to ventilate the interior when cooking or if the use of your air conditioner is not desired. If used properly the roof fan can cool the interior by as much as 15 degrees within a short period of time. When used in the exhaust mode, the fan pulls hot air from high inside the coach and will pull fresh air from an open window.

This fan is usually controlled by a wall-mounted thermostat (some models have a thermostat built right on the fan), which must be turned on and adjusted to your desired temperature before use. The wall-mounted thermostat is not the same that is used for the furnace or air conditioners. Please review the supplied fan owner's manual for additional operating instructions.

Effects of Long Term Occupancy

More and more today motor homes are being used for more than just recreational vehicles. Those of you that intend to use the vehicle for extended periods of time must be prepared to deal with condensation and the humid conditions that may be encountered. The normal activities of even a small number of occupants in the relatively small volume of a modern recreational vehicle with its tight construction will lead to rapid saturation of the air inside the vehicle and the appearance of visible moisture, especially during cold weather.

Estimates indicate that a family of four can vaporize up to three gallons of water daily through its breathing, cooking, bathing and washing. Unless this vapor is carried outside by ventilation, or removed from the air by a dehumidifier, it will condense on the inside of the windows and walls as moisture. In cold weather it will appear as frost or ice. It may also condense in the walls or ceiling and appear as stains on paneling. This will increase the heating load on the furnace somewhat, but it will greatly reduce condensation. You should increase ventilation when large numbers of people are present.

CAUTION: DO NOT USE COOKING APPLIANCES FOR COMFORT HEATING. IN ADDITION TO THE TOXIC FUMES AND OXYGEN DEPLETION, OPEN FLAMES ADD MOISTURE TO THE AIR INCREASING CONDENSATION.

SLIDE OUT SYSTEMS

If your vehicle is equipped with a slide out there are several precautions that should be taken before operation of the slide room.

1. Make sure you have clearance on the exterior.
2. Make sure your slide out awning is unlocked.
3. Make sure that all interior items are clear.
4. Make sure that you have sufficient battery power.

Hydraulically operated rooms require a fluid level check every time the RV is used. This practice should be included in your pre-travel checklist. If you find that your fluid is low, use a ten-(10) weight hydraulic fluid to fill the reservoir to the proper level. Usually the fill cap has a fluid level indicator attached.

If your slide out room fails to move in or out you may have a low battery. Make sure that the battery is fully charged and try the operation again (the slide out will not operate on the converter alone, also, a battery that reads 12 volts may not be at full amperage capacity). If the hydraulic slide out room has to be manually moved in or out, refer to the instructions listed on the hydraulic reservoir for proper manual operation. If the procedures are not listed contact the hydraulic system manufacturer or your nearest Gulf Stream dealer for assistance.

Slide out Kill Switch

Some Gulf Stream models have a kill switch mounted to the base of the driver's seat. The slide out will not function unless this seat is moved to its forward most position.

Slide out Circuit Breaker Switch

If attempting to move the slide and its perceived that the pump has no power, check the 12 volt 50 amp mini-breaker located in either the front or rear exterior electrical compartment to make sure it has not been tripped. Reset the breaker as needed.

Slide out Weather Seals

Periodically check all seals and gaskets on the slide out walls for proper fit and operation. Check the condition of the slide tubes (not the hydraulic ram) under the slide out, and if needed use bearing grease for ease of operation.

Slide outs are not designed to have a 100% air-tight seal, however, you will find that the best seal possible can be achieved with pro-active maintenance and proper use.

Slide out Ignition override

The slide out has a safety override installed to prevent operation while the ignition switch is on. Make sure the ignition switch to the motor home is off before troubleshooting any slide out problems such as, non operation.

VEHICLE MAINTENANCE

Generally, sealants are designed to last more than a few years, however, the varying weather conditions across the country, and vastly different climates from Canada to the Rio Grande, can breakdown those sealants in as little as 1 year. Some sealants applied in the spring must be touched up again in the fall, and in the windshield area on a bi-monthly basis. The

windshield is probably subjected to the worse conditions, and therefore will require more maintenance. If the windshield leaks, a good urethane adhesive designed for installing windshields is recommended for application under the rubber gasket, followed up by a small silicone seal where the gasket lays on the windshield.

Probably the most important area to check for proper seals, is the roof. Generally, this area should be checked at least twice a year. If you find any area that looks questionable, reseal it. The sealant that you should use depends on what type has already been applied. Most rubber roofs used on RV's today use a sealant that is "Self-Leveling," or gradually spreads out up to an hour after it is applied. Before this type of sealant is applied it may be necessary to remove all sealant in the questionable area, as this will ensure that the new sealant will get a good seal when applied. Due to the fact that this sealant tries to settle after it is applied, it is not recommended for application in areas that travel over the edge of the roof. In these areas a good silicone sealant of the same color will perform the task at hand.

Other areas that will need attention include the moldings used on the side walls and the compartment door edge moldings. Since these areas are more accessible for periodical checks, It is recommended to inspect the side walls and compartment doors every time you wash your vehicle. Sometimes washing the side walls can actually remove some necessary sealants. If you find an area on your side walls that needs resealed, a clear silicone, or one that matches the color of your side walls should be used. When resealing compartment doors, only a clear silicone sealant is recommended, as these doors are usually painted and the color would be difficult to match.

The last few areas that might need attention are those around the clearance lights, tail lights, rear view mirrors, and around accessories and windows. All these areas can be resealed using a common silicone based sealant/adhesive. However, when sealing windows and the base of rear view mirrors, be careful as to keep from sealing over any weep holes. These holes are designed to drain any water that may have found its way to the inside of a window or mirror.

Keeping up on the maintenance of your sealants will keep your RV looking beautiful for a long time. If you are not sure what types of sealants should be used on any part of your RV, a simple phone call to your local dealer for direction will prove beneficial.

If you plan on using wax on your side walls you should use a marine type wax on the unpainted portions of the coach. Marine type wax is best suited for fiberglass surfaces. Regular automotive wax is suitable for painted surfaces of the RV.

Corrosion Protection

Your Gulf Stream recreational vehicle has been designed to withstand normal environmental conditions. But, the sand and salt used on the highways and the salt spray in the air near oceans can cause the metal components on your recreational vehicle to corrode.

To protect your recreational vehicle from this corrosion, it must be thoroughly cleaned as soon as possible after exposure to these elements. Washing the undercarriage with a high-pressure washer will remove the majority of the salt. But, this will not replace the paint that is literally sand-blasted off the undercarriage by the road salt and sand. Sand-blasted and corroded frame components must be refinished. This can be done with readily available rust preventative paint and undercoating. This is necessary to properly maintain your recreational vehicle.

We have also found generators to be affected by salt spray. Since the generator requires air for operation and cooling, the generator compartment cannot be completely sealed from the elements. Therefore, whenever the recreational vehicle is exposed to salt spray, the generator should also be cleaned.

Aftermarket undercoating processes are also beneficial in rust prevention. But, to remain effective, these treatments must be inspected and renewed annually as most undercoating agents can dry and peel with age.

Therefore, regularly scheduled inspections and maintenance is necessary to protect your recreational vehicle and its various components and fixtures from the elements and keep it corrosion-free.

In addition to maintenance, you should keep from storing your vehicle in grassy areas for long periods of time. The stagnant, moist air developed under the coach will speed up the corrosion process. Always store your vehicle on pebble, concrete or asphalt.

LEVELING JACKS

Leveling jack systems are installed to level your coach, and to keep the coach from swaying when parked for camping. Leveling jacks were not designed as lifting systems for service access under the coach. Placement of ANSI approved jack stands under the coach is necessary prior to entering the underside of any vehicle for service.

Due to the varying options contained in leveling jack systems, it is recommended that you read the operation manual included with the system installed on your coach (optional) for proper operation procedures.

Leveling Jack Circuit Breaker Switch

If you are having trouble with the system, make sure that the 50 amp 12 volt mini breaker installed in either the front or rear exterior electrical compartment has not been tripped. Your batteries must be near fully charged to operate the leveling system as well. Also make sure that you have the ignition key in the proper position, the brake is set, and that the transmission is in "park."

AWNINGS

Awnings installed on your vehicle are optional and may have been added by your dealer. Proper use, care, and maintenance procedures for awnings are included in the literature provided with the awning.

To open your main awning:

- Make sure that you have sufficient clearance from obstructions.
- Unlock the awning using the provided wand. Pull down the locking latch located on the top of the right awning arm.
- Unlock the travel lock on the awning arm, if equipped.
- Loosen the rafter arm knobs located in each awning arm.
- Using the wand, hook the loop hanging in the center of the awning and pull the awning completely out.
- Slide each rafter arm to the top of each awning arm and tighten the rafter knobs, making sure the awning fabric is not loose.
- Near the base of each awning arm is a flip-out lever/handle, which is also an awning arm slide lock. When the lever is flipped out, the awning arm can be slid up to raise the awning. Flipping the lever back down will allow the arm to lock.
- Your awning is now in place. You may choose to use anchor straps for extra support in windy conditions.

To close the main awning:

- Flip the awning arm levers out and slide the awning arms back down, being careful not to let the awning drop down, as flipping the levers out will unlock the arm and allow it to slide down.
- Loosen the rafter arm knobs and slide the rafter arm as far down as it will go. Do not re-tighten the rafter arm knobs at this time.
- While holding the wand strap in the awning tube, push the awning main latch located on the top of the right arm to "locked." BE CAREFUL! This will cause the awning to roll up if you don't have a good hold of the awning tube strap.
- Holding the awning tube strap, allow the awning to roll up until you can use the wand in the strap. Using the wand, allow the awning to roll all the way up. Do not

allow the strap to get rolled all the way in the awning fabric.

-Lock the awning arm travel latches.

-Re-tighten the rafter arm knobs located in each awning arm.

Window awnings do not need to be unlocked for use. Simply use the awning wand and hook the awning strap located in the center of the window awning. Pull the window awning completely out and hook the strap onto the hook installed on the side wall of the coach.

Awning Care

Be sure to clean off all debris as you roll up your awnings. Periodically wash off the awning fabric with a soapy water solution. Long term exposure to the sun may cause some fading over time, which is normal.

REPORTING SAFETY DEFECTS

If you believe that your vehicle has a defect which could cause a crash or could cause injury or death, you should immediately inform the National Highway Traffic Safety Administration (NHTSA) in addition to notifying Gulf Stream Coach, Inc.

If NHTSA receives similar complaints, it may open an investigation, and if it finds that a safety defect exists in a group of vehicles, it may order a recall and remedy campaign. However, NHTSA cannot become involved in individual problems between you, your dealer, or GULF STREAM COACH, INC.

To contact NHTSA, you may either call the Auto Safety Hotline toll-free at 1.800.424.9393 or write to : NHTSA, U.S. Department of Transportation, Washington, D.C. 20590 or at www.NHTSA.gov. You can also obtain other information about motor vehicle safety from the hotline.

PRE-TRIP CHECK LIST(AT HOME)

EXTERIOR

- All objects (mirrors, etc.) secure..... _____
- Awnings locked..... _____
- Tires at proper pressure (spare)..... _____
(check for wear/damage)
- Wheel lug nuts at proper torque..... _____
- Hitch and hitch ball secure..... _____
- All exterior lights operational..... _____
- Windshield wipers operational (blades) _____
- Batteries charged, fluid level okay..... _____
- Fluid topped off..... _____
(oil, brake, trans, anti-freeze/coolant)
- Belts and hoses in good condition..... _____
(check belt tension and hose clamps)
- Brakes checked for operation..... _____
- Secure all compartment doors..... _____
- Under-carriage items secure..... _____
- Roof items secure..... _____

INTERIOR

- Antenna lowered..... _____
- Roof vents lowered..... _____
- Refrigerator locked..... _____
- Water heater OFF..... _____
- Water pump OFF..... _____
- Fresh water tank level..... _____
- Waste water tank levels..... _____
- Toilet operational..... _____
- Furnace OFF..... _____
- LP Gas System checked..... _____

- Cooktop Cover CLOSED..... _____
- Drawers, Closets, Windows CLOSED... _____
- START ENGINE, CHECK GAUGES.... _____
- Horn..... _____
- Radio..... _____
- Seat adjustments..... _____
- Mirror adjustments..... _____
- Dashboard lights..... _____

PRE-TRIP CHECK LIST(CAMPSITE)

FOLLOW THE ABOVE CHECK LIST WITH THESE ADDED POINT:

EXTERIOR

- Disconnect all shore lines..... _____
(City water, electric, sewer, cable)
- Remove wheel chocks..... _____
- Retract step..... _____
- Retract Levelers..... _____
- Store camping equipment..... _____

CHECK CLEARANCES PRIOR TO PULLING OUT

This check list may seem like it contains basic items, but many are taken for granted and can spoil a camping trip if not attended to prior to moving the vehicle.

You may want to use this list as a start for your own Pre-Trip check list, which may include your personal camping gear and food preferences.

INDEX

12-VOLT/110-VOLT.....	13
30-AMP AND 50-AMP 110-VOLT SERVICE.....	14

A

AIR BAG (SUSPENSION) WARNING.....	8
AIR CONDITIONER (ROOF).....	25
ANTI-LOCKING BRAKING SYSTEM (ABS).....	11
APPLIANCES.....	23
AUTOMOTIVE 12-VOLT SYSTEM.....	15
AWNING CARE.....	27
AWNINGS.....	27

B

BATTERY TYPES AND CHARGING.....	16
BATTERY.....	16
BRAKES.....	10

C

CARBON MONOXIDE SAFETY.....	4
CARRYING CAPACITY.....	5
CHILD'S SAFETY SEATS.....	4
CITY WATER.....	20
CLIMATE DIFFERENCES (LP).....	18
COACH SYSTEMS.....	13
CORROSION PROTECTION.....	27

D

DANGERS OF OVERLOADING.....	8
DASH SWITCH SYMBOLS.....	12
DASHBOARD INSTRUMENTS.....	11
DAY-TO-DAY OPERATION.....	10
DETERMINING WEIGHT AND WEIGHT DISTRIBUTION... ..	7
DO'S AND DON'TS OF HOLDING TANK USE.....	22
DRAINAGE AND SEWER.....	21
DRAINAGE P-TRAPS.....	22
DRIVER CONTROLS.....	10
DRIVING TECHNIQUES.....	10

E

EFFECTS OF LONG TERM OCCUPANCY.....	25
ELECTRICAL.....	13
EMERGENCY TOWING OF MOTOR HOME.....	10
EMPTYING HOLDING TANKS.....	22

F

FANTASTIC FAN OPERATION.....	25
FEDERAL WEIGHT DEFINITIONS.....	6
FILLING THE LP TANK.....	18
FIRE SAFETY.....	4
FRESH WATER.....	20
FURNACE.....	24

G

GAS LINE CHECK (LP).....	19
GAS TANK AND REGULATOR FREEZE UP (LP).....	19
GASOLINE TANK SAFETY.....	5

GENERAL SAFETY.....	3
GROUND CLEARANCE.....	10
GROUND FAULT INTERRUPTER.....	15
GULF STREAM WARRANTY.....	1
GULF STREAMERS INTERNATIONAL RV CLUB.....	32

H

HOLDING TANK FLUSH SYSTEM.....	22
HOLDING TANK MAINTENANCE.....	22
HOLDING TANKS.....	22
HOSE REPLACEMENT (LP).....	19

I

INVERTER.....	16
---------------	----

J

JUMP STARTING.....	12
--------------------	----

L

LEVELING JACK CIRCUIT BREAKER.....	27
LEVELING JACKS.....	27
LOADING TIPS.....	6
LP GAS SAFETY.....	2
LP GAS SAFETY.....	5
LP GAS.....	18

M

MANUFACTURERS LABELS.....	6
METHOD OF WEIGHING YOUR VEHICLE.....	7
MICROWAVE.....	24
MONITOR PANEL.....	17

O

ONBOARD AUXILIARY POWER GENERATOR.....	16
--	----

P

PAC BRAKES AND JAKE BRAKES.....	11
PLUMBING.....	20
POWER CONVERTER.....	15
PRE-TRIP CHECK LIST.....	29

Q

QUICK FILL WATER SUPPLY.....	20
------------------------------	----

R

RANGE.....	24
REFRIGERATOR.....	24
REGULATOR PRESSURE (LP).....	19
REGULATOR VENT MAINTENANCE (LP).....	19
REPORTING SAFETY DEFECTS.....	28

S

SAFETY.....	13
SANITIZING THE WATER TANK.....	20
SEAT BELT MAINTENANCE.....	4
SEAT BELT MOUNTING.....	4
SEAT BELT USAGE.....	3
SECONDARY WATER PUMP SWITCH.....	21
SLIDE OUT BREAKER SWITCH.....	26
SLIDE OUT KILL SWITCH.....	26
SLIDE OUT SYSTEMS.....	25

SLIDE OUT WEATHER SEALS.....	26
SMOKE DETECTOR.....	4
SOLAR CHARGER.....	17
STARTING AND VEHICLE WARM UP.....	12

T

TELEVISION 12-VOLT ELECTRICAL CONNECTION.....	17
TIRE AIR PRESSURE.....	9
TIRE LOAD RATINGS.....	9
TIRE MAINTENANCE.....	9
TIRE MARKINGS.....	9
TIRES.....	9
TURBO DIESEL OPERATING INSTRUCTIONS.....	12
TV ANTENNA AND CABLE CONNECTIONS.....	17

U

UNUSED DASHBOARD SWITCH LOCATIONS.....	12
--	----

V

VEHICLE LOADING.....	5
VEHICLE MAINTENANCE.....	26
VEHICLE TOWING (DINGHY).....	9
VEHICLE WEIGHT INFORMATION LABEL.....	9
VEHICLE WEIGHT PLANNING GUIDE.....	8

W

WARM WEATHER/HIGH ELEVATION OPERATION.....	10
WATER HEATER.....	24
WATER MANIFOLD SYSTEM.....	21
WATER PUMP.....	21
WATER SYSTEM WINTERIZING.....	23
WATER TANK.....	20
WEIGHT DISTRIBUTION FORMULAS.....	7
WINTERIZING BYPASS OPTION ON MANIFOLD.....	21
WINTERIZING THE WATER PUMP.....	21

GULF STREAMERS INTERNATIONAL RV CLUB



BENEFITS



For being an important member of our club, we wish to offer you these valuable Gulf Streamer benefits.

1. Active Chapters: Members are encouraged to join and participate in their local chapter activities. If there is not one in your state, we will help you promote the club to get a chapter started. For more details, contact the International Office.
2. MAIN STREAM: The MAIN STREAM newsletter is issued quarterly to keep you informed of upcoming International events, local chapter happenings, and Gulf Stream product and service updates.
3. GULF STREAMERS "10% PROGRAM": This program enlists campgrounds to offer you a ten percent discount on select camping throughout the United States and Canada.
4. Fellowship and Friendship: RVers are a special breed! The Gulf Streamers club will give you a chance to meet many who share this wonderful pasttime.
5. Discounts: Members receive discounts on National Theme Parks and special attractions. You also receive special rates on RV and travel guides, directories and magazines.
6. STREAMWEAR by Gulf Stream: As a member of the Gulf Streamers, you have the opportunity to order hats, jackets, shirts and sweaters with the Gulf Streamers logo. Attractive apparel offered at special club prices.
7. Promotional Items: Offered only to members of the Gulf Streamers club. Items include Flying "G" decals and Gulf Streamers flags at special discounted prices.
8. Fellowship Rallies and Caravans: Five International events a year that are professionally scouted and pre-planned for your convenience. Pre-scouted events with experienced wagonmasters to help make your trip trouble-free and more enjoyable.
9. Gulf Streamers Country Club: Open Memorial Day - Labor Day. A home for the Gulf Streamers International RV Club; a place where owners of Gulf Stream RVs can relax and enjoy the many outstanding recreational activities as an associate member of our 55-acre complex. The complex includes a nine-hole par-3 golf course, shuffleboards, basketball/tennis courts, swimming pool, a clubhouse and more.
10. Hertz - Discount Card: As a member you receive special car rental rates, discounts and program enhancements such as weekly rental discounts and free car class up-grades.
- *11. Gulf Streamers RV Insurance: An outstanding opportunity that offers members full coverage at competitive prices. Policies cover both full and part-time RVers at special rates, including diminishing deductibles.
- *12. Gulf Streamers Emergency Road Service: An opportunity to receive 100% paid road service, no limit towing, fuel delivery and many other benefits at special prices. Exclusively available for the Gulf Streamers International RV Club.

Membership Application (Please Print)

Name _____

Spouse _____

Address _____

City _____ St./Prov. _____

ZIP _____ Phone _____

Model _____ Year _____

Unit Serial # _____

Membership Sponsored by _____

Sponsor Membership # _____

Check One:

Membership Dues Renewal/Reinstatements

One Year (\$25) One Year (\$20)

Two Years (\$40) Two Years (\$35)

Three Years (\$50) Three Years (\$45)

Check or Money Order Only (in U.S. Funds). Complete this application for membership and mail with your check or money order to: Gulf Streamers International RV Club
P.O. Box 1005, Nappanee, IN - 46550-0905 (219) 773-7761.

